



OPERATOR'S MANUAL

NPB-4000/4000C Patient Monitor

Nellcor Puritan Bennett Inc. is an affiliate of Tyco Healthcare. *Nellcor, Nellcor Puritan Bennett, Durasensor, C-LOCK, Oxisensor II, Dura-Y*, and the Nellcor Puritan Bennett knob configuration are trademarks of Nellcor Puritan Bennett Inc.

To obtain information about a warranty, if any, for this product, contact Nellcor's Technical Services Department, or your local Nellcor representative.

**Covered by one or more of the following U.S. Patents and foreign equivalents:
4,621,643; 4,653,498; 4,700,708; 4,770,179; 4,869,254; 5,368,224 Re. 35,122;
4,928,692; 4,934,372; 5,078,136.**

CONTENTS

Figures
Tables

Safety Information	1
General Safety Information	1
Introduction	5
Intended Use	5
About This Manual	5
Controls, Indicators, And Symbols	7
Front Panel	7
Rear Panel	13
Quick Guide To Operation	15
Features	17
Physical/Mechanical	17
Electrical	18
Display	18
Auxiliary Outputs	19
Options and Accessories	19
Setup and Use	21
Unpacking and Inspection	21
Power Cable Connections	22
Measurement Cable Connections	22
Power On and Self-Test	24
Set Date and Time	26
Display and Operation	29
The Display Configuration	29
Controlling Monitor Operation and Display Elements	35
Alarms and Limits	41
General	41
Alarm Priority	42
Loss-Of-Monitoring Alarm	43
Visual Alarm Indicators	43
Audible Alarm Indicators	44
Setting And Changing Alarm Limits	45
Using The Alarm/Limits Screen	45
Auto-Set Alarm Limits	50
Using The Numeric Frame	50
Alarm Limits and Factory-Set Default Values	50
Alarm Silence Switch	51
Alarm Suspend	52
ECG Monitoring	55
General	55
ECG Safety Information	55

Setup Connections.....	57
Controlling ECG Functions Via Numeric Frame	60
Controlling ECG Waveform Via Graphic Frame	61
NIBP Monitoring.....	65
General	65
NIBP Safety Information.....	65
Setup Connections.....	67
NIBP Measurement Modes.....	68
Controlling NIBP Functions Via Numeric Frame.....	71
SpO2 Monitoring	73
General	73
SpO2 Safety Information	74
Setup Connection.....	75
Controlling SpO2 Functions Via Numeric Frame	78
Controlling SpO2 Waveform Via Graphic Frame	80
Respiration Monitoring.....	83
General	83
Respiration Safety Information.....	83
Setup Connections.....	84
Controlling Respiration Functions Via Numeric Frame	84
Controlling Respiration Waveform Via Graphic Frame.....	86
Temperature Monitoring.....	89
General	89
Controlling Temperature Functions Via Numeric Frame ..	90
Trends.....	91
General	91
Displaying Trend Data.....	92
Selecting A 2-Hour Portion Of The Graphical Trend For Display:.....	94
Printing Trend Information (Printer Option Installed):	95
Changing The Vertical Scale Range	95
Selecting Different Trend Records.....	96
Graphical Trend Operation Summary.....	97
Tabular Trend Data.....	98
Transferring Trends Via RS-232	98
Printing	99
General	99
Operator Maintenance and Troubleshooting.....	103
Error Messages.....	103
Service	103
Obtaining Technical Assistance.....	105
Returning System Components	105
Printer Paper Replacement.....	106
Specifications.....	109
Scope	109

General	109
Electrical	110
Environmental	111
Measuring Parameters	111
Trends	115
RS-232 Interface.....	117
Overview	117
Cable Connection	117
Nurse-Call	118
Exporting Trend Data.....	118
Defib Sync Output	122
Defib Sync Output.....	122
NPB-4000/C Defib Sync	122
Optional Accessories	123
Printer	123
GCX Mount.....	123
Accessory Bag	123
Defib Sync Cable	123
DC Input Cable	123

FIGURES

Figure 1: Front Panel, NPB-4000/C.....	7
Figure 2: Rear Panel, NPB-4000/C	13
Figure 3: NPB-4000/C Patient Monitor	17
Figure 4: Copyright Screen.....	25
Figure 5: Typical Screen for No Patient Leads	25
Figure 6: Typical Screen, Valid Monitored Signals	26
Figure 7: A Typical Monitoring Screen.....	30
Figure 8: Big Numbers Screen	34
Figure 9: Highlighted ECG Graphic; Level 1 and Level 2 Menus.....	37
Figure 10: SpO2 Screen.....	38
Figure 11: Alarm/Limits Screen Presentation	46
Figure 12: Alarm Suspend Screen	52
Figure 13: Standard ECG Leads Placement	58
Figure 14: Modified Chest Lead (MCL1) Placement (if using MCL1, select Lead II).....	59
Figure 15: Heart Rate Display	60
Figure 16: ECG Waveform	62
Figure 17: NIBP Screen.....	71
Figure 18: SpO2 Screen.....	78
Figure 19: SpO2 Waveform Screen	80
Figure 20: Respiration Rate Screen	84

Figure 21: Respiration Waveform Screen	86
Figure 22: Temperature Screen.....	90
Figure 23: Graphical and Tabular Trend Screens	93
Figure 24: Accessing the Trend Scroll Capability	96
Figure 25: Printer Operator Controls.....	99
Figure 26: Real-Time Printout.....	100
Figure 27: Graphic Trend Printout	101
Figure 28: Tabular Trend Printout.....	101
Figure 29: Loading Thermal Paper in Printer.....	106

TABLES

Table 1: Front Panel Connectors	8
Table 2: Switch Panel Symbols	8
Table 3: Display Symbols.....	10
Table 4: Rear Panel Connectors.....	13
Table 5: Quick Guide Procedure	15
Table 6: Battery Charging Front panel Indications.....	24
Table 7: NPB-4000C Color Description	31
Table 8: NPB-4000C Battery Icon.....	33
Table 9: SpO2 Screen Menus.....	39
Table 10: Visual Alarm Flashing Rates.....	43
Table 11: Audible Alarm Characteristics.....	44
Table 12: Alarm/Limits Menu	46
Table 13: Auto-Set Limits Formulas	50
Table 14: Alarm Limits Ranges and Factory-Set Limits.....	51
Table 15: ECG Lead Color Coding	58
Table 16: ECG Lead Pairs (for Standard Leads Placement)....	59
Table 17: Heart Rate Menu.....	60
Table 18: ECG Waveform Menu	63
Table 19: Cuff Sizes.....	67
Table 20: Low Priority NIBP Alarms.....	70
Table 21: NIBP Menu.....	72
Table 22: SpO2 Sensors.....	76
Table 23: SpO2 Menu.....	79
Table 24: SpO2 Waveform	81
Table 25: Respiration Rate Menu	85
Table 26: Respiration Waveform Menu	87
Table 27: Temperature Menu	90
Table 28: SpO2 Graphical Trend Menu.....	97
Table 29: RS-232 Serial Interface Connections	117

SAFETY INFORMATION

General Safety Information

GENERAL SAFETY INFORMATION

This section contains important safety information related to general use of the NPB-4000 monochrome display patient monitor and NPB-4000C color display patient monitor. Other important safety information appears throughout the manual in sections that relate specifically to the precautionary information. Read all text surrounding all precautionary information. The monitors will be referred to as NPB-4000/C throughout this manual.

Important! Before use, carefully read this manual, accessory directions for use, all precautionary information in boldface type, and specifications.

WARNING: In the USA, do not connect to an electrical outlet controlled by a wall switch because the device may be accidentally turned off.

WARNING: As with any medical equipment, carefully route patient cabling to reduce the possibility of patient entanglement or strangulation.

Warning: Do not use the NPB-4000/C patient monitor to monitor neonates.

WARNING: Explosion hazard. Do not use the NPB-4000/C in the presence of flammable anesthetics or gases.

WARNING: The NPB-4000/C patient monitor is a prescription device and is to be operated by qualified personnel only.

WARNING: The user must check the equipment prior to use and ensure its safe and proper use.

WARNING: The NPB-4000/C is defibrillator proof. It may remain attached to the patient during defibrillation or while an electrosurgical unit is in use, but the readings may be inaccurate during use and shortly thereafter.

WARNING: The NPB-4000/C is intended only as an adjunct in patient assessment. It must be used in conjunction with clinical signs and symptoms.

WARNING: To ensure patient safety, do not place the monitor in any position that might cause it to fall on the patient.

WARNING: Disconnect the NPB-4000/C and sensors during magnetic resonance imaging (MRI) scanning. Use during MRI could cause burns or adversely affect the MRI image or the monitor's accuracy. Also, to avoid burns, remove the sensors from the patient before conducting MRI.

WARNING: Do not lift the monitor by the sensor cable, blood pressure hose, or power cord because the cable, lead, or cord could disconnect from the monitor, causing the monitor to drop on the patient.

WARNING: Do not use the NPB-4000/C to monitor patients who are linked to heart/lung machines.

WARNING: The NPB-4000/C may not operate effectively on patients who are experiencing convulsions or tremors.

WARNING: Occasionally, electrical signals at the heart do not produce a peripheral pulse. If a patient's beat-to-beat pulse amplitude varies significantly (for example, pulsus alternans, atrial fibrillation, rapid-cycling artificial ventilator), blood pressure and pulse rate readings can be erratic and an alternate measuring method should be used for confirmation.

CAUTION: When connecting the NPB-4000/C patient monitor to any instrument, verify proper operation before clinical use. Both the NPB-4000/C and the instrument connected to it must be connected to a grounded outlet. Accessory equipment connected to the monitor's data interface must be certified according to IEC Standard 950 for data-processing equipment or IEC Standard 601-1 for electromedical equipment. All combinations of equipment must be in compliance with IEC Standard 601-1 system requirements. Anyone who connects additional equipment to the signal input or signal output port configures a medical system and is therefore responsible that the system complies with the requirements of standard IEC Standard 601-1-1. If in doubt, consult Nellcor's Technical Services Department or your local Nellcor's representative.

[THIS PAGE INTENTIONALLY LEFT BLANK]

INTRODUCTION

Intended Use
About this Manual

INTENDED USE

The purpose and function of the Nellcor NPB-4000/C patient monitor is to monitor ECG, heart rate, noninvasive blood pressure (systolic, diastolic, and mean arterial pressures), functional arterial oxygen saturation, respiration, and temperature for adult and pediatric patients in all hospital areas and hospital-type facilities. It may be used during hospital transport and in mobile, land-based environments, such as ambulances.

<p>WARNING: The NPB-4000/C is intended only as an adjunct in patient assessment. It must be used in conjunction with clinical signs and symptoms.</p>
--

ABOUT THIS MANUAL

This manual explains how to set up and use the NPB-4000/C patient monitor. Important safety information relating to general use of the NPB-4000/C appears before this introduction. Other important safety information is located throughout the text where applicable. **Read the entire manual including the *Safety Information* section, before you operate the monitor.**

[THIS PAGE INTENTIONALLY LEFT BLANK]

CONTROLS, INDICATORS, AND SYMBOLS

Front Panel
Rear Panel

FRONT PANEL

See Figure 1. The front panel controls and indicators are arranged in groups:



Figure 1: Front Panel, NPB-4000/C

1. Display: (the major area of the panel)
2. Switch Panel: (to the right of the display)
3. Patient Connectors: (along the bottom of the panel)
4. Control Knob: (the lower right corner of the panel)

Patient Monitoring Connectors



All patient connections to the NPB-4000/C are classified as type CF, which specifies their degree of protection against electrical shock, and all are rated as defibrillator-proof. Consequently, each connector is marked with the following symbol.

Symbol for Defibrillator-proof
Type CF Equipment



A unique icon identifying the parameter being monitored through that connector identifies each connection. Table 1 defines the monitored parameter, connector compatibility, and icon.

Table 1: Front Panel Connectors

Monitored Parameter	Connector Compatibility	Icon
ECG	Compatible with Nellcor CE-10 ECG Cables	
SpO₂	Compatible with Nellcor sensors and sensor extension cables	SpO₂ %
NIBP	Compatible with Nellcor SHBP-10 blood pressure hose	
Temperature	Compatible with YSI Series 400 temperature probes	<i>T</i>

Switch Panel

The symbols identifying the switches and light emitting diode (LED) indicators on the Switch Panel are described in Table 2.

Table 2: Switch Panel Symbols







Switched/LED Descriptor	Icon	Operation
On/Standby Switch		Toggles NPB-4000/C between ON and STANDBY modes

Table 2: Switch Panel Symbols

Switched/LED Descriptor	Icon	Operation
AC source LED Indicator		When lit, indicates an AC source connected and charging the battery
DC source LED Indicator		When lit, indicates a DC source connected and charging the battery
NIBP Start/Stop Switch		Toggles between starting and stopping NIBP measurement
NIBP STAT icon		Indicates STAT mode, which is activated by pressing and holding the NIBP switch for 2 seconds
Alarm Silence Switch		Temporarily silences the audible alarm sound for a pre-set interval
Heart Rate Tone Volume Switch		Enables the knob to adjust volume of the audible tone
Contrast Adjust Switch		<p>NPB-4000 Pressing switch causes screen contrast to change to an average setting. Also enables the knob to adjust the contrast of the display.</p> <p>NPB-4000C Pressing switch causes the screen to switch to the alternate set of colors (black background vs. white background).</p>

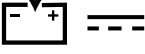
Display Symbols

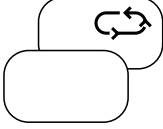
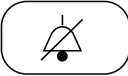
The symbols and icons used in the NPB-4000/C patient monitor display are described in Table 3.

Table 3: Display Symbols









Display - Numeric Frame Symbols	
Heart Rate	
 /min	Heart rate icon. Identifies the frame and indicates the units, beats per second. Always displayed.
SpO₂ %	Heart rate determined from SpO ₂ sensor. Displayed when heart rate is derived from the SpO ₂ sensor.
	Heart rate determined from ECG measurement. Displayed when heart rate is derived from the ECG measurement.
	Heart rate determined from NIBP measurement. Displayed when heart rate is derived from the NIBP measurement.
	Heart rate alarm. Displayed when a heart rate alarm limit has been violated.
	Audible Alarm Off. Displayed when audible alarm is silenced. This icon is in reverse video to indicate that the audible alarm is temporarily silenced.
SpO₂	
SpO₂ %	SpO ₂ frame icon. Identifies the frame and indicates the units (percent). Always displayed.
	Pulse amplitude indicator.
	SpO ₂ alarm. Displayed when an SpO ₂ alarm limit has been violated.
	Audible Alarm Off. Displayed when the audible alarm is silenced. This icon is in reverse video to indicate that the audible alarm is temporarily silenced.

Table 3: Display Symbols















NIBP	
 mmHg	NIBP icon and units of measure
140/90 (106)	Systolic blood pressure/Diastolic blood pressure (Mean arterial pressure value)
	Auto mode icon and minutes between automatic NIBP measurement
	STAT mode icon appears when STAT mode is active
180	Display of the initial cuff pressure to be used on the next measurement.
 17	Timer icon and minutes since last NIBP measurement
	NIBP alarm. Displayed when an NIBP alarm limit has been violated.
	Audible Alarm Off. Displayed when audible alarm is silenced
Respiration Rate	
 /min	Respiration icon and units of measure
	Respiration alarm. Displayed when a respiration rate alarm limit has been violated.
	Audible Alarm Off. Displayed when audible alarm is silenced
Temperature	
T	Temperature icon
C	Temperature unit of measure, ° C or ° F
	Temperature alarm. Displayed when a temperature alarm limit has been violated.
	Audible Alarm Off. Displayed when audible alarm is silenced.

Table 3: Display Symbols

Display - Graphic Frame Symbols	
ECG Waveform	
	ECG icon
	Size bar, 1 cm high
0.5 $\frac{mV}{cm}$	Size scale
II	Lead pair
SpO₂ Waveform	
SpO ₂ %	SpO ₂ icon
Respiration Waveform	
	Respiration icon

REAR PANEL

Five connectors are located on the rear panel of NPB-4000/C. See Figure 2 and refer to Table 4. The rear panel includes threaded standoffs for attaching a GCX mounting system accessory.

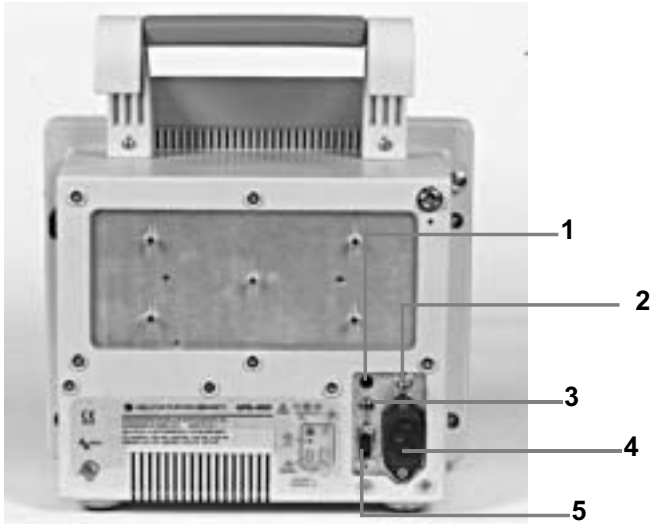
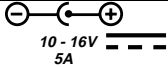

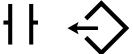



Figure 2: Rear Panel, NPB-4000/C

Table 4: Rear Panel Connectors

Figure 2 Callout	Description	Connector Type	Icon
1	DC Input	2-line; + and ground	
2	Equipotential	Equipotential ground	
3	Defib Sync	2.5 mm subminiature phone jack	
4	AC Input	3-line connector, IEC 320 receptacle	100 - 240V ~ 50 - 60 Hz 1 A
5	RS-232 I/O	DB-9 (male)	

[THIS PAGE INTENTIONALLY LEFT BLANK]

QUICK GUIDE TO OPERATION

Table 5: Quick Guide Procedure









Step	Icon	Operation
1	...	Connect patient cables to front panel connectors (refer to Setup & Use , page21).
2	...	As appropriate, attach cuff, sensor, electrodes, probe to patient and cables to the monitor (refer to Monitoring sections pages 55, 65, 73, 83 and 89).
3		Press <i>On/Standby</i> switch to turn monitor on. The NPB-4000/C will go through a self-test before displaying the monitoring screen.
4		Check the alarm limits; adjust if required. Rotate the knob to highlight the <i>Alarm Limits icon</i> , then press the knob to view all alarm limits. To change a limit, rotate the knob until the desired limit is highlighted, then press the knob. Rotate the knob again until desired value is obtained. Repeat as necessary. Upon completion, rotate the knob to highlight Return, then press the knob to exit the monitoring screen (refer to Alarms & Limits , page 41).
—		NPB-4000 To adjust the screen contrast, press the <i>Contrast Adjust</i> switch and rotate the knob to give the best viewing angle. NPB-4000C To adjust color set, press the <i>Contrast switch</i> until the screen provides an optimum contrast in the intended setting.
—		To adjust the heart rate tone volume, press the <i>Heart Rate Tone Volume</i> switch and rotate the knob to give the desired volume.

Table 5: Quick Guide Procedure

Step	Icon	Operation
—		<p>To initiate a blood pressure measurement, press the <i>NIBP Start/Stop</i> switch. Press and hold the <i>NIBP Start/Stop</i> switch for 2 seconds to initiate STAT mode. A press during any measurement terminates the measurement and deflates the cuff (refer to NIBP Monitoring, page 65).</p>
—		<p>To temporarily silence an audible alarm, press the <i>Alarm Silence</i> switch (refer to Alarms & Limits, page 41).</p>
—		<p>To produce a 20-second printout (if optional printer installed), press <i>Snapshot</i> switch on the printer. Press the <i>Continuous</i> switch to produce a continuous printout (refer to Printing, page 99).</p>
5		<p>Press the <i>On/Standby</i> switch to terminate monitoring and blank the screen.</p>

FEATURES

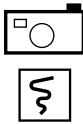
Physical/Mechanical
Electrical
Display
Auxiliary Outputs
Options and Accessories

PHYSICAL/MECHANICAL

The NPB-4000/C patient monitor is a lightweight, compact, multi-parameter patient monitor measuring 10.6 in x 8.6 in x 6.5 in (26.5 cm x 21.8 cm x 16.5 cm) and weighing 10.8 lb (4.9 kg) without printer, cable, and accessories. Its carrying handle is designed for instrument transport while battery-powered monitoring continues.

The optional printer is installed within the case, adding 0.9 lb (0.4 kg) to the monitor weight.

Mounting attachments are provided on the case for use with an optional GCX mounting system. Refer to **OPTIONAL ACCESSORIES** section, page 123.



Figure 3: NPB-4000/C Patient Monitor

ELECTRICAL

The NPB-4000 is powered by an internal battery pack that provides 4 hours of monitoring from fully charged batteries (typical, performance is at 25° C, with no printing, and one NIBP measurement every 15 minutes). The batteries are continuously recharged when AC or DC power is connected to the monitor.

The NPB-4000C is powered by an internal battery pack that provides 3 hours of monitoring from fully charged batteries (typical, performance is at 25° C, with no printing, and one NIBP measurement every 15 minutes). The batteries are continuously recharged when AC or DC power is connected to the monitor.

Battery charging is indicated by front panel green LCDs. Two LCDs are used, one for AC and one for DC. When operating on batteries, a battery “gauge” icon in the lower part of the display indicates the battery charge condition.

A warning message appears on the screen and an audible alarm sounds when the remaining battery power is only enough for 15 minutes of operation. The user should connect the monitor to an external power source to avoid loss of patient monitoring action.

External power sources may be connected, disconnected, and reconnected without interrupting the monitoring action.

DISPLAY

The NPB-4000 monitoring screen is a monochrome LCD display that shows all graphic and numeric patient information as well as alphanumeric status conditions and warning messages.

The NPB-4000C monitoring screen is a color LCD that shows all graphic and numeric patient information as well as alphanumeric status conditions and warning messages.

The graphics, text, and numeric information are grouped into areas through which the user interacts to control the monitoring functions and elements of the screen information.

Control Knob and Menu

The Control Knob provides user interaction with the display and the monitor functions.

Rotating and pressing the knob allows a user to navigate and make changes to the display elements and monitor functions. Details of this interactive operation are described in the **Display & Operation** section, page 29.

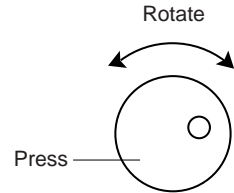

AUXILIARY OUTPUTS

The NPB-4000/C monitor exports trend data via an RS-232 I/O port. The port also provides the capability for initiating a Nurse Call upon alarm. Refer to the **RS-232 INTERFACE** section, page 117, for additional information.

The monitor generates a defibrillator synchronization signal, Defib Sync. The Defib Sync signal is available at the monitor rear panel. Refer to the **DEFIB SYNC OUTPUT** section, page 122.

OPTIONS AND ACCESSORIES

Refer to the **OPTIONAL ACCESSORIES** section, page 123, for descriptions of the monitor's options and accessories.

[THIS PAGE INTENTIONALLY LEFT BLANK]

SETUP and USE

Unpacking and Inspection
Power Cable Connections
Measurement Cable Connections
Power On and Self Test

WARNING: The NPB-4000/C is a prescription device and is to be operated by qualified personnel only.

WARNING: In the USA, do not connect to an electrical outlet controlled by a wall switch because the device may be accidentally turned off.

WARNING: As with all medical equipment, carefully route patient cabling to reduce the possibility of patient entanglement or strangulation.

WARNING: Do not use the NPB-4000/C patient monitor to monitor neonates.

CAUTION: If the NPB-4000/C is to be stored for a period of 2 months or longer, notify service personnel to remove the battery from the monitor prior to storage. Recharge the battery when the battery has not been recharged for 2 or more months.

CAUTION: Follow local government ordinances and recycle instructions regarding disposal or recycling of device components, including batteries.

UNPACKING AND INSPECTION

The NPB-4000/C patient monitor is shipped in one carton. Examine the carton carefully for evidence of damage. Contact the carrier immediately if any damage is discovered.

Retain all packing material. Refer to the **Operator Maintenance and Troubleshooting** section, page 103, for instructions on returning damaged items.

POWER CABLE CONNECTIONS

AC Power

Ensure that the AC outlet is properly grounded and of the specified voltage and frequency (100-240 VAC, 50-60 Hz). Connect the AC power cord to the monitor rear panel connector identified with the AC power icon. See Figure 2, page 13. Use only a Nellcor supplied power cord. If in doubt about the integrity of the grounding of the AC power source, the monitor must be operated from its internal battery.

DC Power

Connect an external DC power source (10 to 16 volts DC) to the monitor rear panel connector identified with the DC power icon. See Figure 2, page 13. Use only a Nellcor DC input cable. The user must ensure that connection to the external DC supply meets all applicable safety codes.

MEASUREMENT CABLE CONNECTIONS

<p>WARNING: Do not lift the monitor by the sensor cables, blood pressure hose, or power cord because the cable, lead, or cord could disconnect from the monitor, causing the monitor to drop on the patient.</p>

ECG Cable and Leads

Use only a Nellcor CE-10 ECG cable and LE-Series ECG leads with the NPB-4000/C or, or an ECG cable and leads recommended by Nellcor Technical Services.

Connect the cable to the front panel connector marked with the ECG icon. See Figure 1, page 7, and refer to Table 1, page 8.

Connect leads to the patient as described in the **ECG Monitoring** section, page 55.

NIBP Hose and Cuff

Use only a Nellcor SHBP series hose and SCBP-Series cuff with the NPB-4000/C, or a hose and cuff recommended by Nellcor Technical Services.

Refer to the **NIBP Monitoring** section, page 65. Select the appropriate size cuff for the patient. Apply the cuff to the selected limb. Connect the hose to the front panel connector marked with the NIBP icon. See Figure 1, page 7, and refer to Table 1, page 8.

SpO₂ Cable and Sensor

Use only Nellcor sensor extension cables and SpO₂ sensors with the NPB-4000/C.

Refer to the **SpO₂ Monitoring** section, page 73. Select an appropriate sensor for the patient and desired application. Apply the sensor to the selected site. Connect the sensor to the cable, and connect the cable to the front panel connector identified with the SpO₂ icon. See Figure 1, page 7, and refer to Table 1, page 8.

Temperature Probe

The monitor uses YSI Series 400-compatible temperature probes. Insert the plug into the compatible jack on the monitor front panel marked with the temperature icon. See Figure 1, page 7, and refer to Table 1, page 8. Refer to **Temperature Monitoring** section, page 115 for details.

POWER ON AND SELF-TEST

WARNING: If you do not hear the POST (power on self-test) pass tone, do not use the monitor.

WARNING: Disconnect the NPB-4000/C and sensors during magnetic resonance imaging (MRI) scanning. Use during MRI may cause burns or adversely affect the MRI image or the monitor’s accuracy

CAUTION: If any indicator or display element does not light, do not use the monitor. Instead, contact qualified service personnel, your local Nellcor representative, or the Nellcor’s Technical Services Department.

Note: The battery may be discharged upon receipt. It will be fully charged after the first 8 hours the monitor is connected to an AC or DC power source.

Internal batteries that are charged by NPB-4000/C connection to external AC or DC sources supply the monitor power. The front panel display indicates the status of external power sources, as summarized in Table 6.

Table 6: Battery Charging Front Panel Indications

External Power Connections	Front panel Indications
AC source	AC icon lighted
DC source	DC icon lighted
None	Battery “gauge” appears in display. No LED lit

After patient sensors are connected to their input cables, turn the monitor ON by pressure the front panel *On/Standby* switch. Audible feedback after pressing a front panel switch indicates that the monitor is processing the action.

A copyright screen appears while the NPB-4000/C runs a set of self-diagnostic test routines. See Figure 4. The copyright screen displays the version of software installed in your unit. Call Nellcor's Technical Services for the latest applicable software and to inquire about software updates.



Figure 4: Copyright Screen

After power-up diagnostics are completed successfully, the NPB-4000/C initiates monitoring operation. If no leads have been connected to the patient, the display appears similar to that shown in Figure 5.

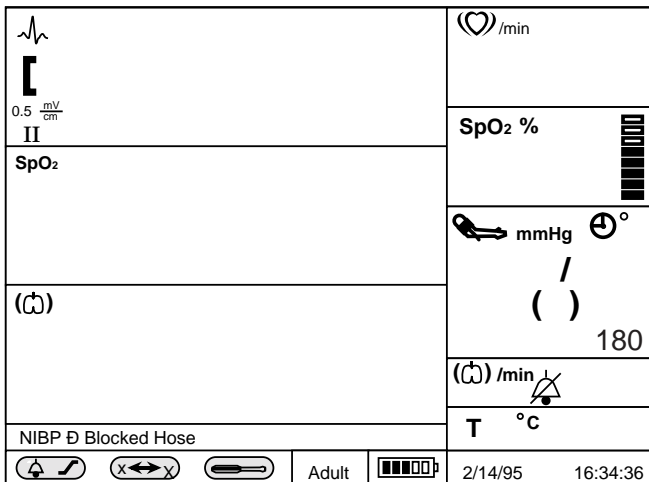

Figure 5: Typical Screen for No Patient Leads

When the monitor detects valid signals a typical presentation with two real-time waveforms and a tabular trend appears. See Figure 6.

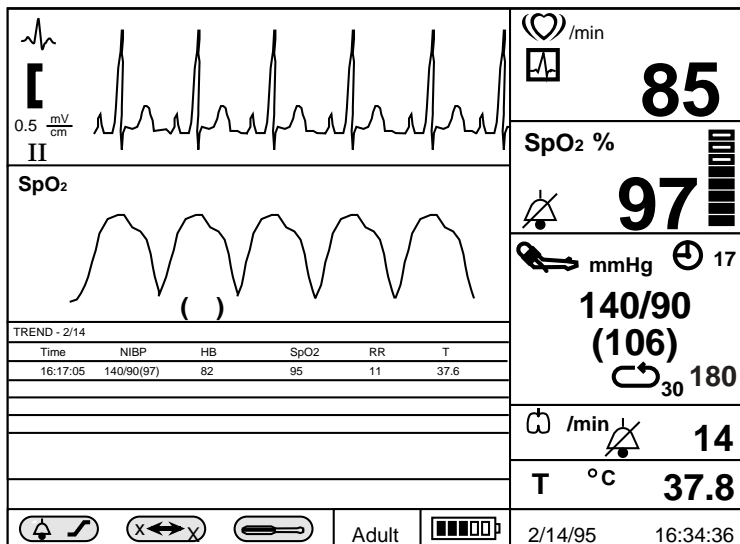

Figure 6: Typical Screen, Valid Monitored Signals

If the *ON/Standby* switch is pressed when in the monitoring mode, the monitor is placed in the Standby mode, in which:

- The display is blanked
- Trend data taken during the monitoring mode remains stored in memory
- No further monitoring takes place
- Battery charging continues if the monitor is connected to an AC or DC power source

SET DATE AND TIME

This procedure will enable you to set the date and time displayed on the screen and printed on the reports. Setting the date and time is accomplished by rotating and pressing the control knob.

Note: Read all procedure steps before trying to make any changes. The display will return to the normal display screen if the knob is not rotated or pressed for 20 seconds.

1. Rotate the knob to highlight the date time box. A dark border appears around the frame.
2. Press the knob. Date/Time menu appears.
3. Rotate the knob to highlight Date Format.
4. Press the knob. The date formats appear.
5. Rotate the knob to highlight: mm/dd/yy or dd/mm/yy.
6. Press the knob. The highlighted format appears after the Date Format menu entry.
7. Rotate the knob to highlight Set Date.
8. Press the knob. A date appears.
9. Rotate the knob to highlight the section of the date to be changed.
10. Press the knob. Selects the parameter to be changed.
11. Rotate the knob until the desired number is displayed.
12. Press the knob. The desired number is entered into the monitor.
13. Repeat steps 9 through 12 until the desired date is entered.
14. Rotate the knob to highlight Return.
15. Press the knob. The display returns to the Date/Time menu.
16. Rotate the knob to highlight Set Time.
17. Press the knob. A time appears.
18. Rotate the knob to highlight the section of the time to be changed.
19. Press the knob. Selects the parameter to be changed.
20. Rotate the knob until the desired number is displayed.
21. Press the knob. The desired number is entered into the monitor.
22. Repeat steps 18 through 21 until the desired time is entered.
23. Rotate the knob to highlight Return.
24. Press the knob. The display returns to the Date/Time menu.
25. Rotate the knob to highlight Return.
26. Press the knob. The display returns to the normal monitoring screen.

[THIS PAGE INTENTIONALLY LEFT BLANK]

DISPLAY and OPERATION

The Display Configuration
Controlling Monitor Operation and Display Elements

WARNING: The NPB-4000/C is intended only as an adjunct in patient assessment. It must be used in conjunction with clinical signs and symptoms.

WARNING: Each time the monitor is used, check alarm limits to ensure that they are appropriate for the patient being monitored.

WARNING: The nurse call feature should not be used as the primary source of alarm notification. The audible and visual alarms of the monitor, used in conjunction with clinical signs and symptoms, are the primary source for notifying medical personnel that an alarm condition exists.

THE DISPLAY CONFIGURATION

General

The display in Figure 7, page 30, is of a typical monitoring condition with three waveforms. The display is divided into a number of **areas** that are further subdivided into **frames**.

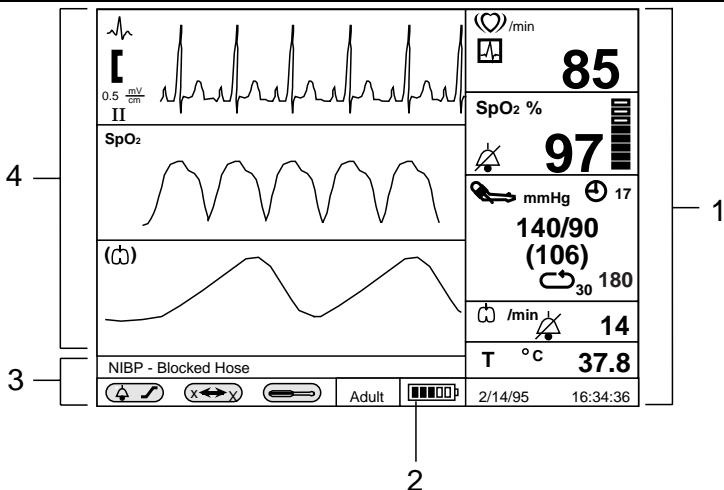

Figure 7: A Typical Monitoring Screen

1. Numeric Area
2. Gauge Indicates Monitor is Using Only Battery
3. Message/menu area
4. Graphic Area

Color Display

The NPB-4000C patient monitor has a color liquid crystal display (LCD). The NPB-4000C LCD performs the same functions as the NPB-4000 LCD except that the display is in color. The colors are function related as shown in Table 7, page 31.

Note: The *Contrast Adjust* switch is implemented differently on the NPB-4000 and the NPB-4000C. See Table 2, page 8.

Table 7: NPB-4000C Color Description

Function	Color
ECG/Heart Rate	Green
SpO2	Blue
NIBP	Red
Respiratory	Yellow
Temperature	Orange
General Background	Black or white depending on the color set selected by the <i>Contrast Adjust</i> switch.
Medium Priority Alarm	Flash Yellow (numeric frame background)
High Priority Alarm	Flash Red (numeric frame background)
Battery Icon (normal)	Green
Battery Icon (low battery)	Yellow or Red (refer to Table 8, page 33)

Numeric Area/Frames

The right-hand area of the display is the numeric area and contains six frames in which numeric values are displayed. Five of the frames contain suitable icons relating the values to monitored patient parameters; the sixth frame displays time and date.

Numeric Frames

From top to bottom, the six numeric frames display the following:

- Heart Rate in beats/minute
- SpO2 in percent saturation
- NIBP Systolic/Diastolic (Mean Arterial Pressure) in mmHg
- Respiration Rate in breaths/minute

- Temperature in ° C or ° F
- Date and Time: mm/dd/yy or dd/mm/yy for date, and 24-hour format for time

The numeric frames always represent the icon-indicated vital signs and may not be reassigned, resized, or resequenced.

Graphics Area/Frames

The upper left area is called the **graphics area** and it contains three equally sized **graphics frames** in which real-time physiological waveforms, graphical trend, or tabular trend data are displayed.

When the ECG leads are connected to the patient, the top graphics frame always displays the ECG waveform. In the remaining two graphic frames, the user may select available waveforms or trend. The waveforms or trends appearing in the frames at power-up are factory set, but may be changed by qualified service personnel with passcode access.

When a menu setup is selected, a single menu frame in which submenus and selectable parameter values are displayed for user selection replaces the lower two graphics frames.

Message/Menu Frames

The area below the graphics area is called the **Message/Menu** area. The upper of two frames in this area is reserved for messages. These are in simple language and describe alarm conditions. The message remains displayed until the problem is resolved, or it may be cleared by pressing the front panel *Alarm Silence* switch. If there is more than one message, each is displayed for 1 second.

The lower of the two sets of frames in this area is used to show status icons and to provide menu choices.

Status Icons

Battery Icon:

The Battery-in-Use icon (at the right end of the frames) appears whenever the monitor is operating on battery power alone. The icon is in the form of a “gauge” providing a graphic indication of remaining battery power. In the NPB-4000, the icon flashes when the monitor detects low battery power. In the NPB-4000C, the icon is displayed as indicated in Table 8.

Table 8: NPB-4000C Battery Icon

Number of Bars Illuminated	Color Used	Behavior
3, 4, or 5	Green	Constant display
2	Yellow	Constant display
1	Red	Constant display
0	Red	Icon flashes and message displayed

Operating Mode:

The operating mode “Adult” is indicated at the left of the battery gauge. The Adult operating mode accommodates both adult and pediatric patients.

Menu Icons

There are three icons in the Menu portion of the Message/Menu area: Alarm/Limits, Big Numbers, and Setup.

Alarm/Limits Icon:

When selected, a menu appears in Frames 2 and 3 of the Graphics Area. The user may view the current alarm limit settings, or may modify them.

Big Numbers Icon:

When selected, a **Big Numbers** display format is generated, and five numeric frames of monitored patient vital signs are enlarged and replace the lower two graphic frames and the six numeric frames. See Figure 8. The time value is moved to the upper right of the screen.

Setup Icon:

When selected, a menu of general-purpose parameters is presented in the graphics area. The user activated Nurse Call signal, if connected. Qualified service personnel can change the Power-Up Default settings of the monitor by using the Enter Power-Up Default Menu. This function is passcode protected, and is further described in **Power-Up Default Settings** section, page 35.

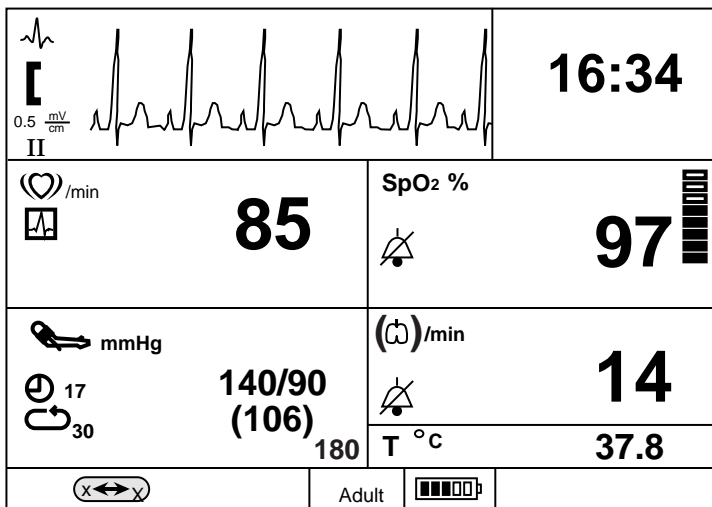

Figure 8: Big Numbers Screen

Big Numbers Screen

The Big Numbers screen provides numeric values that can be read at a distance, and may be more useful to the clinician. Use of the Big Numbers presentation has the following characteristics.

- Selecting the “Big Numbers” icon from the monitoring screen makes access to Big Numbers; Big Numbers is not a power-up default choice.
- One press or rotation of the knob causes the NPB-4000/C to revert to the monitoring screen.
- Any alarm condition causes the NPB-4000/C to revert to the monitoring screen.
- No changes to the display are possible.
- The top graphic frame remains identical in size and content, whether in normal monitoring screen or Big Numbers screen.
- Single-function buttons in the switch panel operate normally, with one exception: if Alarm Suspend is invoked, the normal monitoring screen immediately replaces Big Numbers.

Power-Up Default Settings

Each time the NPB-4000/C is turned on, a number of settings are automatically configured. These settings include alarm limits, ECG lead selection, type of waveforms and/or trends presented in the graphic frames, heart rate tone source, and others. These settings are known as power-up defaults. Each power-up default is set at the factory; however, qualified service personnel may change the factory-set defaults. Instructions for making these adjustments are found in the NPB-4000/C service manual.

CONTROLLING MONITOR OPERATION AND DISPLAY ELEMENTS

Except for actions initiated by pressing a front panel switch, control of the NPB-4000/C patient monitor is accomplished by using the knob to interact with the appropriate area on the display.

The procedure is the same for all operational and display changes:

1. Rotate the knob to highlight item to be changed.

2. Press the knob to make the change
The monitoring screen is, in effect, a high-level menu. Highlighting an area on the monitoring screen by rotating the knob, and selecting it by pressing the knob, will bring up a Level 1 menu that relates to that screen area. Once in the Level 1 menu, the same action-pair of rotating and pressing the knob to highlight and select a menu item takes place. The response may be effective immediately or may bring up a Level 2 menu that “pops up” on the screen without removing the Level 1 menu.

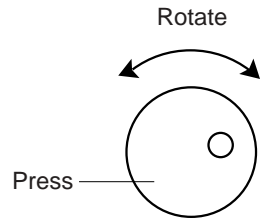

A knob time-out of 20 seconds (no knob action) returns the display to the monitoring screen.

Example of a Change Operation

To change the sweep speed of the ECG waveform presented in the top graphics frame:

1. ROTATE the knob to highlight the ECG graphics frame. A dark border appears around that frame.
2. PRESS the knob. The Level 1 menu appears.
3. ROTATE the knob to highlight Sweep Speed. It appears in reverse video.
4. PRESS the knob. A Level 2 menu appears, and the current value is highlighted in reverse video.
5. ROTATE the knob to highlight a different value in the list.
6. PRESS the knob. The waveform speed is changed to the new sweep speed.
7. ROTATE the knob to highlight Return.
8. PRESS the knob to return to the normal monitoring screen.

Figure 9, page 37, illustrates the process described above.

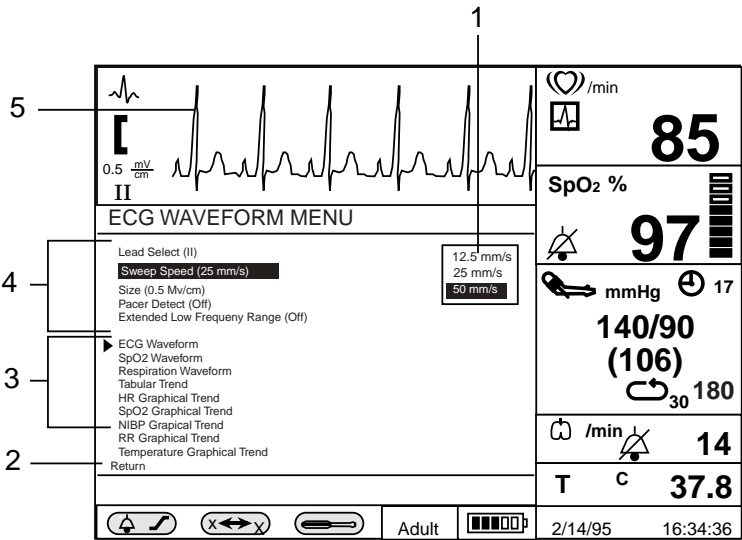

**Figure 9: Highlighted ECG Graphic;
Level 1 and Level 2 Menus**

1. Level 2 Menu
2. Closes Menu
3. List of Other Graphic Types
4. Level 1 Menu Items for Current Graphic Type
5. Highlighted and Selected ECG Waveform

Note: Although other graphic types are listed as possible menu choices for the top graphics frame, they are not available when the ECG cable is connected. If an attempt is made to select another graphic waveform, the following message block appears **“Selection not available.”**

Cascading Waveforms

If a waveform already displayed in a graphics frame is also selected for another frame, then the two frames form a cascaded waveform, effectively presenting a sample over twice the time interval of one frame.

The second half of the cascade may be in any frame, and need not be placed directly under the first frame.

Change Operations Described in Tables

Figure 10 shows an expanded view of a SpO₂ waveform frame. To make a change to this waveform, or put a different type of graphic in its place, rotate the knob until the SpO₂ waveform frame is highlighted, then press the knob. The relevant menu appears in the second and third graphic frames.

Table 9, page 39 details the SpO₂ waveform menu.

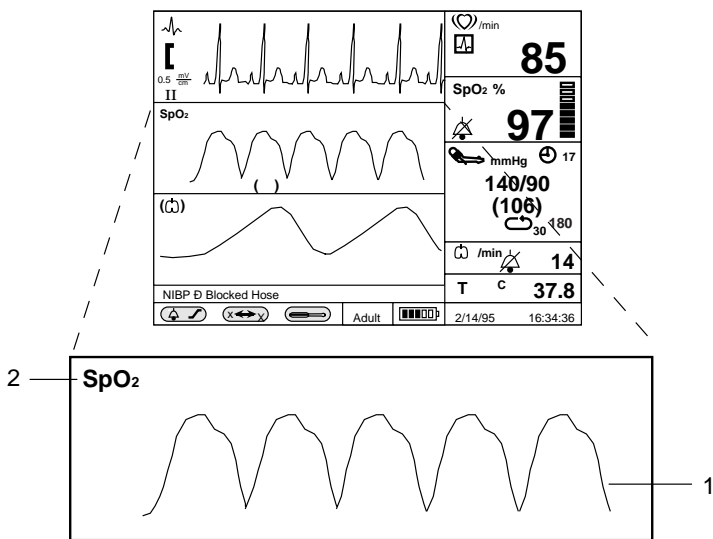

Figure 10: SpO₂ Screen

- 1. SpO₂ Waveform
- 2. SpO₂ Icon

Table 9: SpO₂ Screen Menus

Level 1 Menu Screen	Level 2 Menu or Response
<i>Title: SpO₂ WAVEFORM MENU</i>	
Sweep Speed	12.5 mm/s, 25 mm/s, 50 mm/s
<i>Other graphic type choices:</i> ECG Waveform >SpO₂ Waveform Respiration Waveform Tabular Trend HR Graphical Trend SpO₂ Graphical Trend NIBP Graphical Trend Temperature Graphical Trend	No Level 2 menu for these items; selection of a new graphic type immediately causes the title and the first menu items to update to reflect the new choice.
Return	Exits Level 1 menu immediately, returns to Monitoring Screen

In this example, the only variable setting for the SpO₂ waveform is **Sweep Speed**.

Other graphic types may be selected, as listed. An arrow indicates the current graphic type. The list is the same for all graphic menus.

The final selection is **Return** to monitoring screens.

In this example, there is only one variable parameter (sweep speed. The possible sweep speeds are **12.5, 25, or 50 mm/s**.

Note: Table 9, page 39, incorporates a type-font convention to distinguish what appears on the screen and any descriptive phrase for segments of the information. The screen text is presented in bold font; the descriptive text is in Italics or regular font.

This presentation of the screen frame and the associated tables of menu choices will be used throughout this manual to summarize the monitoring operations and screen presentations.

[THIS PAGE INTENTIONALLY LEFT BLANK]

ALARMS and LIMITS

General
Alarm Priority
Loss-of-Monitoring Alarm
Visual Alarm Indicators
Audible Alarm Indicators
Setting and Changing Alarm Limits
Using the Alarm/Limits Screen
Auto-Set Alarm Limits
Using the Numeric Frame
Alarm Limits and Factory-Set Default Values
Alarm Silence Switch
Alarm Suspend

GENERAL

WARNING: Do not silence the audible alarm or decrease its volume if patient safety could be compromised.

WARNING: Each time the monitor is used, check alarm limits to ensure that they are appropriate for the patient being monitored.

WARNING: The nurse call feature should not be used as the primary source of alarm notification. The audible and visual alarms on the monitor, used in conjunction with clinical signs and symptoms, are the primary source for notifying medical personnel that an alarm condition exists.

When the monitor detects certain conditions that require user attention, the NPB-4000/C monitor enters an alarm state. The monitor response is indicated by:

- Visual alarm indicators
- Audible alarm indicators
- Print-on-alarm (if printer installed)
- Identification of out-of-limit vital signs in trend data
- Nurse-call signal (if connected and enabled)

ALARM PRIORITY

The monitor's visual and audible responses to a detected alarm depend on the priority of the alarm; High, Medium, or Low.

A higher priority alarm will supersede a lower priority alarm. The three categories of alarms are summarized in the following paragraphs. The text in bold font indicates the message shown on the screen. Limit alarms do not have messages.

High Priority:

Asystole (4 seconds have passed with no heart beats from ECG, preceded by detecting valid ECG-derived heart rate data.)

Loss of Pulse from SpO₂ (and no valid ECG)

Medium Priority:

High/Low Heart Rate limits violated

High/Low SpO₂ limits violated

High/Low Sys./Dia./MAP blood pressure limits violated

High/Low Respiration Rate limits violated

High/Low Temperature limits violated

Loss of Respiration Signal

Low Priority:

ECG Leads Off

SpO₂ Cable/Sensor Disconnect

Loss of Pulse from SpO₂ (but there is valid ECG)

Low Battery (alarm commences when the NPB-4000/C has at least 15 minutes of operating time remaining)

Temperature Probe Disconnect

NIBP - No Cuff

NIBP - Blocked Hose

NIBP - Artifact

NIBP - Time-Out

Printer Out of Paper

LOSS-OF-MONITORING ALARM

In the event of a high, medium, or low level alarm, the NPB-4000/C continues to perform monitoring functions. The alarms are designed to alert users of patient or instrument conditions that warrant immediate attention.

A special class of alarms, loss-of-monitoring, occurs when the NPB-4000/C cannot continue to monitor because of an error condition or shutdown because of a low-battery condition.

When a loss-of-monitoring alarm occurs, the NPB-4000/C emits a continuous tone until the *Alarm Silence* switch is pressed.

WARNING: Neither the print-on-alarm nor the nurse-call signal will be initiated when the monitor detects a loss-of-monitoring state.

VISUAL ALARM INDICATORS

When an alarm occurs, the NPB-4000/C responds with visual alarm indications. The flashing rates for the three categories of alarms are shown in Table 10. The NPB-4000C alarms use flashing colors to indicate high and medium priority alarm. Refer to Table 7, page 31.

Table 10: Visual Alarm Flashing Rates

Alarm Category	Flashing Rate
High Priority	Two flashes in 1 second
Medium priority	One flash in 2 seconds
Low priority	Constant (on) (non-flashing)

When a low priority alarm occurs, a non-flashing alarm message appears in the message area. If more than one low priority alarm is present, the alarm messages “rotate”. On the NPB-4000C, the numeric frame background color will change to a solid yellow for a low priority alarm.

When a medium priority alarm is activated because a parameter is outside its alarm limits, the out-of-limit numeric value and the bell icon in the corresponding Numeric Frame flash at the medium priority rate. Only the numeric frame background color will flash yellow for a medium priority alarm in the NPB-4000C.

When the high-priority Asystole alarm occurs, the heart rate numeric value and the corresponding bell icon flash at the high priority rate. Only the numeric frame background color will flash red for a high priority alarm in the NPB-4000C. A non-flashing Asystole message appears in the message area and will override any other messages which may be present (there is no message “rotation” in this instance).

When the high-priority loss of pulse from SpO2 (with no valid ECG) alarm occurs, the SpO2 and heart rate numeric values (which are “0”) and the corresponding bell icons flash at the high priority rate. Only the numeric frame background color will flash red for a high priority alarm in the NPB-4000C. A non-flashing Loss of Pulse from SpO2 message appears in the message area and will override any other messages that may be present (there is no message “rotation” in this instance).

AUDIBLE ALARM INDICATORS

The audible alarm has different tone pitch and on-off beep patterns for each alarm priority. Refer to Table 11.

Table 11: Audible Alarm Characteristics

Alarm Category	Tone Pitch	Beep Rate
High priority	~930 Hz	~ 3 beeps per sec.
Medium priority	~750 Hz	~ 1 beep per sec.
Low priority	~500 Hz	~ 1beep per 4 sec.
Loss-of-monitoring	~3300 Hz	continuous

Note: Visual alarm indicators cannot be suspended or removed. Audible alarms may be decreased in volume or silenced as described in the operational instructions that follow.

WARNING: Do not silence the audible alarm or decrease its volume if patient safety could be compromised.

SETTING AND CHANGING ALARM LIMITS

When the NPB-4000/C is first turned on, alarm limits are set to the power-up default values. Qualified service personnel can change power-up default alarm limits, as described in the NPB-4000/C service manual.

The user can change alarm limits from default values, if necessary, as described below. These changes made by the user will remain in effect until they are modified again, or until the NPB-4000/C is turned off.

WARNING: Each time the monitor is used, check alarm limits to ensure that they are appropriate for the patient being monitored.

Alarm limits may be set in two ways:

- Via interaction with a numeric frame that presents currently measured values of a vital sign, or
- Via interaction with the Alarm/Limits Screen that presents the limits in all measured parameters at one time.

USING THE ALARM/LIMITS SCREEN

Rotate the knob until the Alarm/Limits icon (bell and limits symbol) in the lower left of the monitor screen is highlighted. Press the knob. The Alarm/Limits menu is displayed. The monitor's alarm limits currently in effect for all monitored parameters are displayed at one time.

Figure 11, page 46, illustrates a typical Alarm/Limits screen.

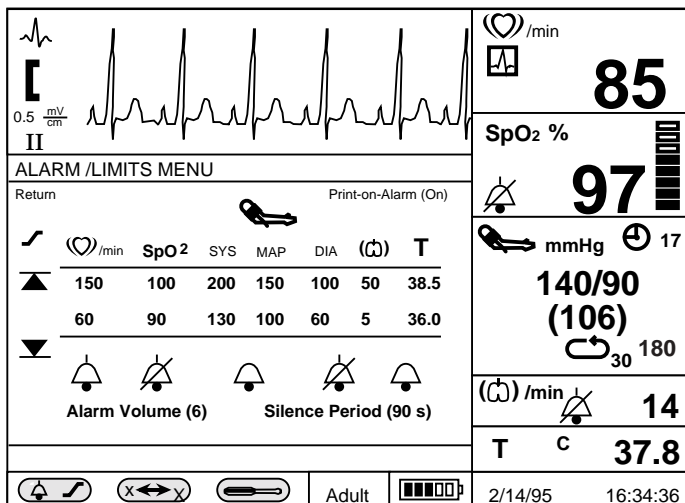

Figure 11: Alarm/Limits Screen Presentation

Operation of the Alarm/Limits Menu is summarized in Table 12.

Table 12: Alarm/Limits Menu

Selected Level 1 Item	Level 2 Screen Menu, or Monitor Response When Selected
Return	Exit menu immediately, returns to Monitoring Screen
Auto-Set Limits	<p>Make No Change to Limits: Limits remain for all parameters as shown.</p> <p>Auto-Set Now: New limits are calculated according to formulas described in Table 13, page 50, and replace those on the screen.</p>

Table 12: Alarm/Limits Menu

Selected Level 1 Item	Level 2 Screen Menu, or Monitor Response When Selected
Print-on-Alarm	<p>On, Off: Optional printer required. Causes a 20-second “snapshot” printout each time a high or medium priority out-of-limits alarm condition occurs. The 20 seconds includes the information from 10 seconds prior to the alarm event. Out-of-limits values are identified in the printout by bracketing them between triangular brackets. An alarm-initiated printout will interrupt any other snapshot or trend printing that may be in process. The interrupted printing will not resume after the alarm-initiated snapshot has been printed.</p>
HR Upper/Lower Limits	<p>Variable: When selected by rotating the knob to highlight the desired limit, pressing the knob enables its subsequent rotation to cycle through possible limit values that appear in place. Pressing knob places the displayed limit in effect.</p>
HR Audible Silence	<p>On/Off: (Bell icon) Toggling action. When OFF is selected, permanently silences the audible alarm for HR limit violations. Bell icon is “slashed” when OFF is selected.</p>
SpO2 Upper/Lower Limits	<p>Variable: When selected by rotating knob to highlight the desired limit, pressing knob enables its subsequent rotation to cycle through possible limit values that appear in place. Pressing knob places the displayed limit.</p>
SpO2 Audible Silence	<p>On/Off: (Bell icon) Toggling action. When Off is selected, permanently silences the audible alarm for SpO2 limit violations. Bell icon is “slashed” when Off is selected.</p>

Table 12: Alarm/Limits Menu

Selected Level 1 Item	Level 2 Screen Menu, or Monitor Response When Selected
SYS Upper/Lower Limits	Variable: When selected by rotating knob to highlight the desired limit, pressing knob enables its subsequent rotation to cycle through possible limit values that appear in place. Pressing knob places the displayed limit in effect.
DIA Upper/Lower Limits	Variable: When selected by rotating knob to highlight the desired limit, pressing the knob enables its subsequent rotation to cycle through possible limit values that appear in place. Pressing knob places the displayed limit in effect.
MAP Upper/Lower Limits	Variable: When selected by rotating knob to highlight the desired limit, pressing the knob enables its subsequent rotation to cycle through possible limit values that appear in place. Pressing knob places the displayed limit in effect.
NIBP Audible Silence	On/Off: (Bell icon) Toggling action. When OFF is selected, permanently silences the audible alarm for NIBP limit violations. Bell icon is “slashed” when OFF is selected.
RR Upper/Lower Limits	Variable: When selected by rotating knob to highlight the desired limit, pressing the knob enables its subsequent rotation to cycle through possible limit values that appear in place. Pressing knob places the displayed limit in effect.
RR Audible Silence	On/Off: (Bell icon) Toggling action. When Off is selected, permanently silences the audible alarm for respiration limit violations and loss of respiration signal alarm. Bell icon is “slashed” when Off is selected.

Table 12: Alarm/Limits Menu

Selected Level 1 Item	Level 2 Screen Menu, or Monitor Response When Selected
<p>Temperature Upper/Lower Limits</p>	<p>Variable: When selected by rotating knob to highlight the desired limit, pressing the knob enables its subsequent rotation to cycle through possible limit values that appear in place. Pressing knob places the displayed limit in effect.</p>
<p>Temperature Audible Silence</p>	<p>On/Off: (Bell icon) Toggling action. When Off is selected, permanently silences the audible alarm for HR limit violations. Bell icon is “slashed” when Off is selected.</p>
<p>Alarm Volume</p>	<p>1, 2, 3, 4, 5, 6, 7, 8, 9: Value increases in eight 5 dBA increments from lowest value of 45 dBA in Step 1 to a maximum of 73 dBA in step 9.</p> <p>If the <i>Alarm Silence</i> switch on the front panel is pressed while setting is changed, the alarm will sound at the volume selected.</p>
<p>Silence Period</p>	<p>30 s, 60 s, 90 s, 120 s: Time is indicated in seconds.</p> <p>Pressing the front panel <i>Alarm Silence</i> switch temporarily silences alarms for the time indicated in the Silence Period menu item. Alarm state(s) in effect at the end of the pre-set interval cause the audible alarm to sound.</p> <p>Pressing the <i>Alarm Silence</i> switch a second time (while the silence interval is still in effect) ends the interval immediately.</p> <p>On the NPB-4000, silencing audible alarms does not affect visual alarm indications.</p> <p>On the NPB-4000C, the visual indication of low priority alarms is cleared by a single press of the <i>Alarm Silence</i> switch.</p>

AUTO-SET ALARM LIMITS

The Auto-Set Limits function allows the user to quickly set alarm limits based on the patient’s current vital sign values. When the Auto-Set Limits item is selected from the Alarm/Limits Menu, the NPB-4000/C takes each currently measured vital sign and applies a calculated offset to each value to generate the new upper and lower alarm limits. Refer to Table 13.

Table 13: Auto-Set Limits Formulas

Parameter	Lower Limit	Upper Limit
Heart Rate (HR)	$(HR) \times 0.75$ or 30 BPM (whichever is greater)	$(HR) \times 1.5$ or 250 BPM (whichever is smaller)
NIBP SYS (SYS)	$(SYS) \times 0.68 + 10$	$(SYS) \times 0.86 + 38$
NIBP DIA (DIA)	$(DIA) \times 0.68 + 6$	$(DIA) \times 0.86 + 32$
NIBP MAP (MAP)	$(MAP) \times 0.68 + 8$	$(MAP) \times 0.86 + 35$
Temperature ° C (T)	$(T) - 0.5$	$(T) + 0.5$
Temperature ° F (T)	$(T) - 0.9$	$(T) + 0.9$
SpO2	Make same as SpO2 power-up default lower limit.	Make same as SpO2 power-up default upper limit.
Respiration Rate (RR)	$(RR) \times 0.5$	$(RR) \times 1.5$

USING THE NUMERIC FRAME

Alarm limits for interacting with the numeric frame for that parameter may set any one physiological parameter. These are described in the chapters covering individual parameter monitoring.

ALARM LIMITS AND FACTORY-SET DEFAULT VALUES

Table 14, page 51, describes the range and increment values that are used to change alarm limits. The values set at the factory for each parameter are also shown.

Table 14: Alarm Limits Ranges and Factory-Set Limits

Parameter	Upper Limits Range/Steps	Factory Defaults	Lower Limits Range/Steps	Factory Defaults
NIBP	100 to 240 mmHg 5 mmHg steps	200 mmHg	60 to 150 mmHg 5 mmHg steps	70 mmHg
NIBP DIA	80 to 180 mmHg 5 mmHg steps	160 mmHg	20 to 120 mmHg 5 mmHg steps	50 mmHg
NIBP MAP	90 to 200 mmHg	180 mmHg	30 to 130 mmHg 5 mmHg steps	60 mmHg
Temp ° C	33° C to 41° C 0.1° C steps	38° C	33° C to 41° C 0.1 ° C steps	36° C
Temp ° F	91° F to 106° F 0.1° F steps	100.6° F	91° F to 106° F 0.1° F steps	96.6° F
Heart Rate	30 to 250 BPM 5 BPM steps	170 BPM	30 to 250 BPM 5 BPM steps	40 BPM
Respiration Rate	3 to 150 BPM 1 BPM steps	40 BPM	3 to 150 BPM 1 BPM steps	4 BPM
SpO ₂ %	20% to 100% 1% steps	100%	20% to 100% 1% steps	85%

Note: High limits cannot be set less than or equal to the low limit. Low limits cannot be set greater than or equal to the high limit.

ALARM SILENCE SWITCH

WARNING: Do not silence the audible alarm or decrease its volume if patient safety could be compromised.

Temporarily silencing the audible alarm is accomplished by pressing the *Alarm Silence* switch on the front panel. This action silences **ALL** audible alarms for a user-controlled preset interval. Refer to **Silence Period** in Table 12, page 46. A reverse-video, slashed-bell icon appears in each numeric frame during a temporary silence period.

ALARM SUSPEND

If the *Alarm Silence* switch is depressed and held for 2 seconds, the Alarm Suspend condition is initiated. Pressing the Alarm Silence switch terminates the Alarm Suspend condition.

When Alarm Suspend is initiated, ALL audible alarms and print-on-alarm functions are disabled. Visual alarms, nurse-call signal, and identification of out-of-limits vital signs in trend memory continue to function. Graphic Frames 2 and 3 are replaced with a prominent warning graphic indicating that the monitor is in Alarm Suspend. See Figure 12.

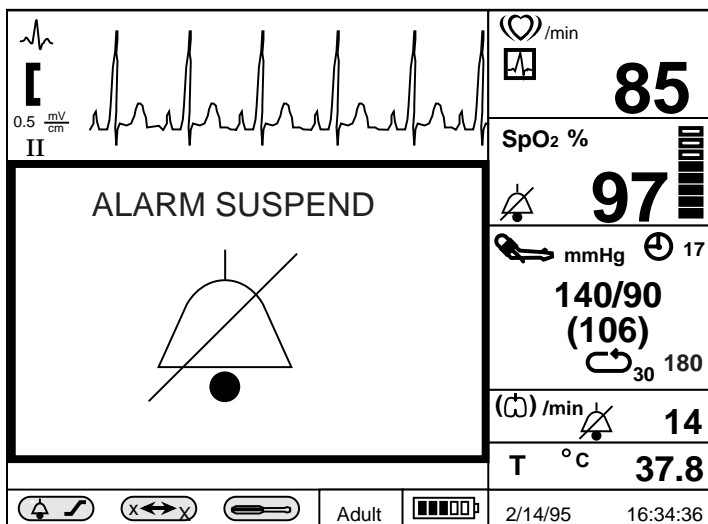

Figure 12: Alarm Suspend Screen

WARNING: If an alarm condition (except those leading to a loss-of-monitoring alarm) occurs while in the Alarm Suspend state, the only alarm indication at the monitor will be visual displays related to the alarm condition.

During Alarm Suspend, monitoring continues for all parameters; the numeric values and the top Graphic Frame (typically ECG waveform) continue to operate normally. Trend memory operates normally. The single-function buttons continue to operate normally. No Level 1 or 2 menus may be invoked while in Alarm Suspend State. Access to the Big Numbers screen is denied while in the Alarm Suspend condition.

[THIS PAGE INTENTIONALLY LEFT BLANK]

ECG MONITORING

General

ECG Safety Information

Setup Connections

Controlling ECG Functions via Numeric Frame

Controlling ECG Waveform via Graphic Frame

GENERAL

The process of depolarization and repolarization of the myocardium generates electric potentials that are sensed by ECG electrodes on the skin surface.

These electrodes are typically attached to the patient's right arm, left arm, and left leg. The monitor processes and amplifies these signals and presents the ECG waveform on the screen.

In addition to the acquisition of the QRS complex, the circuitry performs a number of other functions:

- Computation and display of the heart rate in beats per minute
- Detection of a "lead off" condition if one of the electrode connections is disrupted
- Detection of the presence of pacemaker signals within the waveform complex of the ECG
- Generation of a synchronization pulse for external use with defibrillators. (The Defib Sync Output is available at a connector in the rear panel. Refer to the **DEFIB SYNC OUTPUT** section, page 122, for more details.)
- Selection by the user of an extended low frequency range of signal detection and processing

ECG SAFETY INFORMATION

WARNING: Disconnect the NPB-4000/C and sensors during magnetic resonance imaging (MRI) scanning. Use during MRI could cause burns or adversely affect the MRI image or the monitor's accuracy. Also, to avoid burns, remove the sensors from the patient before conducting MRI.

WARNING: Use only a Nellcor CE-10 ECG cable and LE-Series ECG leads with the NPB-4000/C or an ECG cable and lead recommended by Nellcor's Technical Services. Other ECG cables and leads may cause improper performance and/or provide inadequate protection during defibrillation.

WARNING: Ensure that conductive portions of the electrodes, leads, and cable do not come into contact with any other conductive parts.

WARNING: The NPB-4000/C is defibrillator proof. It may remain attached to the patient during defibrillation or while an electrosurgical unit is in use, but the readings may be inaccurate during use and shortly thereafter.

WARNING: Line isolation monitor transients may resemble actual cardiac waveforms and thus inhibit heart rate alarms. Such transients may be minimized by proper electrode and cable placement, as specified in this manual and electrode directions for use.

WARNING: Do not use damaged ECG leads. Do not immerse ECG leads completely in water, solvents, or cleaning solutions because the connectors are not waterproof. Do not sterilize ECG leads by irradiation, steam, or ethylene oxide. Refer to the cleaning instructions in the directions for use for ECG leads.

WARNING: For pacemaker patients, the NPB-4000/C may continue to count pacemaker rate during occurrences of cardiac arrest or some arrhythmias. To reduce the likelihood of this, ensure that the Pacer Detect setting is ON in the ECG menu when monitoring such patients. Do not rely entirely upon the NPB-4000/C alarms. Keep pacemaker patients under close surveillance.

WARNING: It is possible for the patient to receive a burn due to an improperly connected electrosurgical unit. Additionally, the monitor could be damaged or measurement errors could occur. Certain steps can be taken to mitigate against this problem, such as not using small ECG electrodes, selecting ECG electrode sites remote from the expected RF paths, using large electrosurgical return electrodes, and verifying that the electrosurgical return electrode is properly attached to the patient.

WARNING: ECG cables may be damaged if they are connected to a patient during defibrillation. Cables that have been connected to a patient during defibrillation should be checked for functionality before using again.

SETUP CONNECTIONS

Use only a Nellcor CE-10 ECG cable and LE-Series ECG leads with the NPB-4000/C or an ECG cable and leads recommended by Nellcor's Technical Services.

1. Connect the ECG cable to the ECG input connector on the monitor front panel.
2. Connect the ECG leads to the ECG cable.
3. Select the electrodes to be used. Use only one type of electrode on the same patient to avoid variations in electrical resistance. For ECG monitoring, Nellcor recommends the use of silver/silver chloride electrodes. When dissimilar metals are used for different electrodes, the electrodes may be subject to large offset potentials due to polarization, which may be severe enough to prevent obtaining an ECG trace. Using dissimilar metals may also increase recovery time after defibrillation.
4. Prepare the electrode sites according to electrode manufacturer's instructions. See Figure 13, page 58, and Figure 14, page 58, for electrode placement configurations.
5. Attach the lead wires to the electrodes.

6. Apply the electrodes to the patient as shown in either Figure 13, page 58, or Figure 14, page 59, using the color-code guide in Table 15, page 31.
7. If Standard ECG Lead Placement is used (Figure 13), verify that the desired Lead Selection is active in the ECG waveform frame. Refer to Table 15. Lead II is best suited for most monitoring situations.
8. If Modified Chest Lead is used (Figure 14), verify that Lead II is active in the ECG waveform frame.

Table 15: ECG Lead Color Coding

Lead	AHA	IEC
Right arm (RA)	White	Red
Left arm (LA)	Black	Yellow
Left leg (LL)	Red	Green

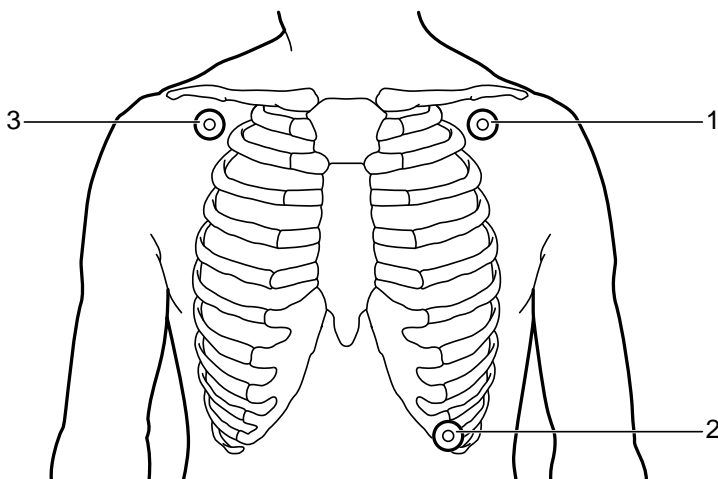
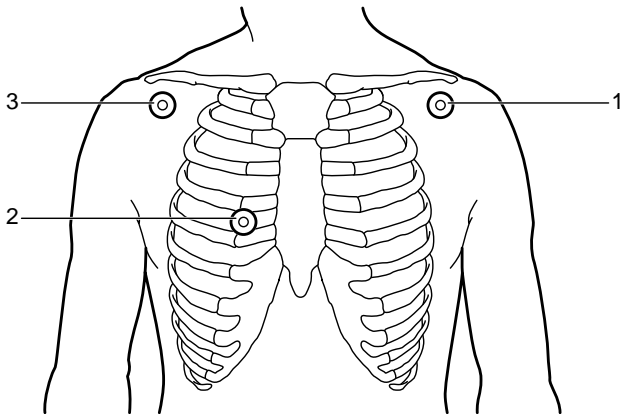

Figure 13: Standard ECG Leads Placement

1 LA 2 LL 3 RA

Table 16: ECG Lead Pairs (for Standard Leads Placement)

Lead-Select Option	Electrode Differential
I	RA → LA
II	RA → LL
III	LA → LL



**Figure 14: Modified Chest Lead (MCL1) Placement
(if using MCL1, select Lead II)**

1 RA 2 LL 3 LA

CONTROLLING ECG FUNCTIONS VIA NUMERIC FRAME

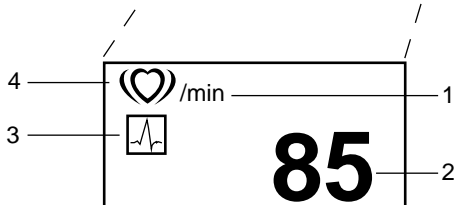
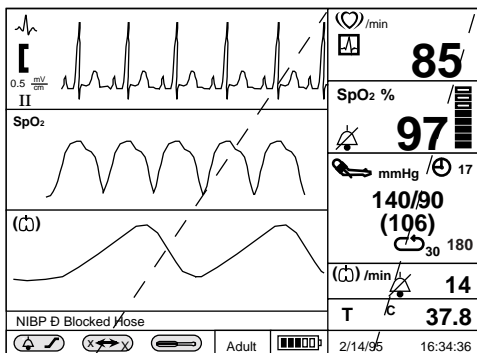

Figure 15: Heart Rate Display

- 1. Units of Measure
- 2. HR Value
- 3. HR Source Icon
- 4. HR Icon

Table 17: Heart Rate Menu

Level 1 Menu	Level 2 Menu or Response
<i>Title: Heart Rate Menu</i>	
Heart Rate Tone Source	SpO2, ECG
Heart rate limits	Variable (refer to Table 13, page 50)
HR alarm silence icon	On/Off
Return	Exits Level 1 menu immediately, returns to Monitoring Screen

The calculated heart rate may be derived from different sources, as shown by the icon in the frame: ECG, SpO₂, or NIBP. The NPB-4000/C automatically derives heart rate from ECG whenever a valid ECG signal is present. If ECG is not present, but SpO₂ is being monitored, the heart rate value is derived from the SpO₂ signal. If neither ECG nor SpO₂ is available, heart rate derived from NIBP will be displayed. If HR is derived from NIBP, that value will only be displayed for 3 minutes after the NIBP measurement, then the value is removed from the display.

A short pulse tone will sound, synchronous with each heartbeat. This heart rate tone may be derived from either of two sources: SpO₂ or ECG, as indicated in Table 17, page 60. When SpO₂ is the source, the pitch varies proportionally with changes in oxygen saturation, rising as SpO₂ increases toward 100%, and falling as it decreases. If the source is ECG, the heart rate tone does not change pitch. The volume of the heart rate tone may be adjusted by pressing the front panel *Heart Rate Tone Volume* switch, then turning the knob.

CONTROLLING ECG WAVEFORM VIA GRAPHIC FRAME

When ECG leads are connected to the patient, the top graphic frame always displays the ECG waveform.

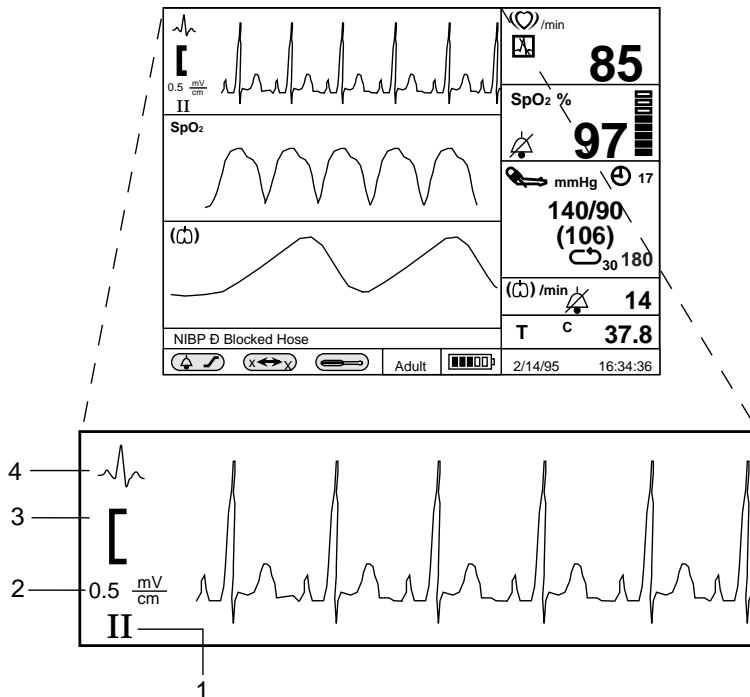

Figure 16: ECG Waveform

1. Lead Pair
2. Size Scale
3. Size Bar 1 cm
4. ECG Icon

The standard size bar, with a height of 1 cm, serves as a visual reference for the ECG waveform.

Table 18: ECG Waveform Menu

<i>Level 1 Menu</i>	<i>Level 2 Menus or Response</i>
<i>Title: ECG WAVEFORM MENU</i>	
Lead Select	I, II, III
Sweep Speed	12.5 mm/s, 25 mm/s, 50 mm/s
Size	0.5 mV/cm, 1 mV/cm, 2 mV/cm, 4 mV/cm
Pacer Detect	On, Off
Extended Low Frequency Range	On, Off
<i>other graphic type choices:</i> >ECG Waveform SpO2 Waveform Respiration Waveform Tabular Trend HR Graphic Trend SpO2 Graphical Trend NIBP Graphical Trend RR graphical Trend Temperature Graphical Trend	No Level 2 menu for these items; selection of a new graphic type immediately causes the title and the first, menu items to update, reflecting the new choice. Note: For consistency, the other display choices are present, but in frame 1 they can not be selected as long as ECG leads are on patient.
Return	Exits Level 1 menu, returns to Monitoring Screen

Extended Low Frequency Range

When Extended Low Frequency Range is On, the monitor provides better ST segment resolution. However, the increased bandwidth may result in low-frequency wander of the ECG baseline, so it is generally recommended that this feature be kept Off except when better ST segment resolution is specifically required.

Pacer Detect

Pacer detect should always be On for patients with pacemakers (refer to safety warning at beginning of chapter). When Pacer Detect is On, the NPB-4000/C detects and filters pacemaker-generated signals so that they will not be measured in determining a patient’s heart rate. Detected pacemaker signals will be displayed on the ECG waveform (screen and printout) as a positive-going spike. Monitoring of non-pacemaker patients is generally not affected when Pacer Detect is enabled; however, in some instances if the patient does not have a pacemaker, it may be desirable to turn the detection function Off so that artifacts in the waveform will not be mistaken for a pacemaker signal.

ECG Leads Off

The NPB-4000/C can determine when all three ECG leads are properly attached to the patient. Should one or more of the leads come off, or lose good electrical contact, after the monitor has established that all 3 leads are attached, a low-priority “ECG Leads Off” alarm will be issued, alerting the caregiver to remedy the problem.

Occasionally, electromagnetic “noise” may cause the ECG circuit to electrically “saturate”. If this condition occurs, the NPB-4000/C will issue an ECG Leads Off alarm. Occurrence is rare, and duration should be short. As soon as the condition ceases, the “ECG Leads Off” alarm will automatically clear.

NIBP MONITORING

General

NIBP Safety Information

Setup Connections

NIBP Measurement Modes

Controlling NIBP Functions via Numeric Frame

GENERAL

NIBP processing by the monitor uses the oscillometric measuring technique. A motorized pump inflates the cuff to initially blocking the flow of blood in the extremity. Then, under monitor control, the pressure in the cuff is gradually reduced, while a pressure transducer detects air pressure and transmits a signal to the NIBP circuitry.

When the cuff pressure is still above systolic pressure, small pulses or oscillations in the cuff pressure begin to be sensed by the transducer. As the cuff continues to deflate, oscillation amplitude increases to a maximum and then decreases. When maximum oscillation amplitude occurs, the cuff pressure at that time is measured as mean arterial pressure (MAP). The systolic and diastolic pressures are calculated based on analysis of the oscillation amplitude profile.

NIBP SAFETY INFORMATION

WARNINGS: Use only SCBP Series Blood Pressure Cuffs and the SHBP-10 Hose or a hose and cuff recommended by Nellcor's Technical Services. Using other cuffs or hoses may result in inaccuracies.

WARNING: Inaccurate measurements may be caused by incorrect cuff application or use, such as placing the cuff too loosely on the patient, using the incorrect cuff size, or not placing the cuff at the same level as the heart, leaky cuff or hose, and excessive patient motion.

WARNING: The NPB-4000/C displays results of the last blood pressure measurement until another measurement is completed. If a patient's condition changes during the time interval between measurements, the NPB-4000/C will not detect the change or indicate an alarm condition.

WARNING: As with all automatically inflatable blood pressure devices, continual cuff measurements can cause injury to the patient being monitored. Weigh the advantages of frequent measurement and/or use of stat mode against the risk of injury.

WARNING: In some cases, rapid, prolonged cycling of an oscillometric, noninvasive blood pressure monitor cuff has been associated with any or all of the following: ischemia, purpura, or neuropathy. Apply the oscillometric cuff appropriately, according to instructions, and check the cuff site and cuffed extremity regularly when blood pressure is measured at frequent intervals or over extended periods of time.

WARNING: Check the patient's limb on which the cuff is applied to assure that circulation is not constricted. Constriction of circulation is indicated by discoloration of the extremity. This check should be performed at the clinician's discretion at regular intervals based on the circumstances of the specific situation.

WARNING: Do not place the cuff on an extremity being used for intravenous infusion or any area where circulation is compromised or has the potential to be compromised.

WARNING: The blood pressure cuff should not be applied to the same extremity as the one to which an SpO₂ sensor is attached, since cuff inflation will disrupt SpO₂ monitoring and lead to nuisance alarms.

WARNING: During use on patients, ensure that heavy objects are not placed on the hose. Avoid crimping or undue bending, twisting, or entanglement of the hose.

Note: A patient’s vital signs may vary dramatically during administration of agents affecting the cardiovascular system, such as those used to raise or lower blood pressure or raise or lower heart rate.

SETUP CONNECTIONS

Use only a Nellcor SHBP-10 hose and SCBP-Series cuff with the NPB-4000/C or a hose and cuff recommended by Nellcor’s Technical Services.

Measure the patient’s limb and select the proper size cuff. As a general rule, cuff width should span approximately two-thirds of the distance between the patient’s elbow and shoulder. Refer to Table 19.

Table 19: Cuff Sizes

Model Number	Limb Circumference Range
SCBR-6R; infant 6 cm (2.4 in.)	10 - 19 cm (4.0 - 7.5 in.)
SCBP-9R; child/adult 9 cm (3.5 in.)	18 - 26 cm (7.1 - 10.2 in.)
SCBP-12R; adult 12 cm (4.75 in.)	25 - 35 cm (9.9 - 13.8 in.)
SCBP-15R; large arm 15 cm (6.0 in.)	33 - 47 cm (13.0 - 18.5 in.)
SCBP-18R; thigh 18 cm (7.1 in.)	46 - 66 cm (18.1 - 26.0 in.)

Follow cuff directions for use for applying the cuff to the arm or thigh. Connect the hose to the front panel connector of the monitor.

NIBP MEASUREMENT MODES

Blood pressure measurements can be made in three modes:

Single

One measurement of each of the three blood pressures (Systolic/Mean Arterial Pressure/Diastolic) is made and displayed in the numeric frame.

Automatic

Measurements are made at preset intervals.

STAT

As many measurements as possible are made within a 5-minute period.

Adjustable Initial Inflation Pressure

The user may select an initial cuff inflation pressure. This is particularly important with children, since an initial cuff inflation pressure of 180 mmHg may be uncomfortable, and is typically higher than it needs to be. The initial inflation pressure can be set from 100 to 280 mmHg, in intervals of 20 mmHg.

The numeric display in the lower right corner of the NIBP frame indicates the setting of the initial inflation pressure which will be used during the next measurement or the instantaneous pressure in the cuff whenever a measurement is underway.

The initial inflation pressure is determined in one of two ways:

1) Upon power up, and immediately after making a change in the adjustable initial inflation pressure via the NIBP menu, the initial inflation pressure is determined by the setting indicated in the NIBP menu. 2) Immediately after an NIBP reading has been successfully completed, the initial inflation value is changed to the just-completed Systolic pressure plus 50 mmHg (rounded off to the nearest 5 mmHg).

To Initiate a Single Blood Pressure Measurement

Press (momentarily) the front panel *NIBP Start/Stop* switch. A single blood pressure measurement will be made.

In addition to displaying the three pressure measurements, the monitor numeric frame displays a clock icon and a numeric value, which indicate the elapsed time in minutes since last taking a measurement.

The measurements remain in the numeric frame for 60 minutes. At the end of the 60-minute interval, the measured value and the icon are removed from the display.

As soon as an NIBP measurement begins, any existing NIBP values in the numeric frame are removed, and the current, variable value of the cuff pressure is shown. Systolic, diastolic, and MAP values are presented when the measurement is completed.

Absence of valid measurement values because of a low-priority alarm condition will result in “dashes” in the display.

To Make NIBP Measurements Automatically

Select the desired automatic measurement interval from the menu, accessed via the NIBP numeric frame. Upon selection, automatic mode is activated and the initial measurement will be made “X” minutes later (where “X” is the chosen interval). If a measurement is desired immediately, press the front panel *NIBP Start/Stop* switch.

The NIBP numeric frame will display the AUTO mode icon and the number of minutes selected for the interval between measurements. This icon and its numeric value are in addition to the clock icon and elapsed time since last measurement.

To initiate STAT mode of NIBP operation

Press the front panel *NIBP STAT* switch and hold it for at least 2 seconds.

While STAT mode is active (5 minutes), the STAT icon appears in the numeric frame; the clock icon and minutes displays are removed.

Upon completion of STAT mode, the last measurement made in that mode is displayed, and both the clock icon and elapsed time numeric return to the display.

At 60 minutes after completion of the STAT measurements, the displayed NIBP measurement and the clock icon are removed.

To Stop Blood Pressure Measurements

If a measurement is in process, press the front panel *NIBP Start/Stop* switch at any time that you wish to stop the current measurement and deflate the cuff. If an automatic measurement is underway, the interval time will be reset.

Low Priority NIBP Alarms

Several conditions may occur to disrupt an NIBP measurement. Table 20 summarizes the conditions and the recommended corrective action.

Table 20: Low Priority NIBP Alarms

Low Priority Alarm Message	Recommended Action
NIBP - No Cuff	Check to see that the cuff is present. Check the cuff and hose connections for leaks. Take a measurement again.
NIBP - Blocked Hose	Check to see that the hose is not obstructed or pinched. Take a measurement again.
NIBP - Artifact	Monitor detected artifact, usually caused by patient movement. In the presence of moderate artifact, the monitor may be able to complete the measurement and display blood pressure values. However, in this case the clinician may wish to repeat the measurement if the values seem questionable. More severe artifact will prevent the measurement from being completed, and dashes will be displayed in the NIBP numeric frame. In this case, check the patient, cuff application and cuff orientation. Take a measurement again.
NIBP - Time-Out	Measurement could not be completed within the normal amount of time. Check the patient. Check the cuff application and orientation. Take a measurement again.

CONTROLLING NIBP FUNCTIONS VIA NUMERIC FRAME

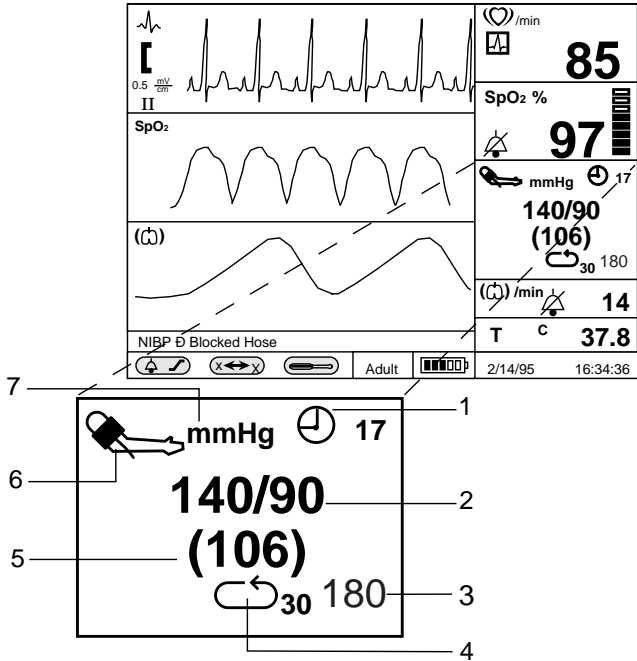

Figure 17: NIBP Screen

1. Timer Icon-Minutes Since Last Measurement
2. Systolic / Diastolic Values
3. Initial cuff inflation pressure (Note)
4. Auto Mode Icon-Interval In Minutes
5. Mean Arterial Pressure Value
6. NIBP Icon
7. Units of Measure

Note: If measurement is underway, this field displays the instantaneous pressure in the cuff.

Table 21: NIBP Menu

<i>Level 1 Menu</i>	<i>Level 2 Menus or Response</i>
<i>Title:</i> NIBP MENU	
Automatic Mode Interval	Off, 1 min, 3 min, 5 min, 10 min, 15 min, 30 min, 60 min, 90 min
Initial Inflation Pressure	100, 123, 140, 160, 180, 200, 220, 240, 260, 280
S/D/M limits	Variable (refer to Table 13, page 50)
Alarm silence icon	On/Off
Return	Exits Level 1 menu immediately, returns to Monitoring Screen

SpO₂ MONITORING

General

SpO₂ Safety Information

Setup Connections

Controlling SpO₂ Functions via Numeric Frame

Controlling SpO₂ Waveform via Graphic Frame

Pulse Search Condition

GENERAL

Pulse oximetry works by applying a sensor to a pulsating arteriolar vascular bed. The sensor contains a dual light source and photodetector. Bone, tissue, pigmentation, and venous vessels normally absorb a constant amount of light over time. The arteriolar bed normally pulsates and absorbs variable amounts of light during systole and diastole, as blood volume increases and decreases. The ratio of light absorbed at systole and diastole is translated into an oxygen saturation measurement. This measurement is referred to as SpO₂.

The NPB-4000/C utilizes *C-LOCK*® ECG synchronization to enhance signal processing during patient movement or poor perfusion. *C-LOCK* synchronization utilizes the QRS signal as a reference point for identifying the oximetry pulse, thus enhancing “good” pulses and reducing the effect of random artifacts associated with motion and low perfusion.

The measured SpO₂ value from an oximeter may differ from the saturation value that is calculated from a blood gas partial pressure of oxygen (PO₂). This usually occurs because the calculated saturation was not appropriately corrected for the effects of variables that shift the relationship between PO₂ and saturation: pH, temperature, partial pressure of carbon dioxide (PCO₂), 2,3-DPG, and fetal hemoglobin.

This monitor measures functional saturation — oxygenated hemoglobin expressed as a percentage of the hemoglobin that can transport oxygen. It does not detect significant amounts of dysfunctional hemoglobin, such as carboxyhemoglobin or methemoglobin. In contrast, hemoximeters such as the IL482 report fractional saturation — oxygenated hemoglobin expressed as a percentage of all measured hemoglobin, including measured dysfunctional hemoglobin. To compare functional saturation measurements to those from an instrument that measures fractional saturation, fractional measurements must be converted as follows:

$$\text{functional saturation} = \frac{\text{fractional saturation}}{100 - (\% \text{ carboxyhemoglobin} + \% \text{ methemoglobin})} \times 100$$

SpO₂ SAFETY INFORMATION

WARNINGS: Use only Nellcor SpO₂ sensors for SpO₂ measurements. Other SpO₂ sensors may cause improper NPB-4000/C performance.

WARNING: Tissue damage can be caused by incorrect application or use of an SpO₂ sensor, for example by wrapping the sensor too tightly or by applying supplemental tape. Inspect the sensor site as directed in the sensor directions for use to ensure skin integrity and correct positioning and adhesion of the sensor.

WARNING: Do not use damaged SpO₂ sensors. Do not use an SpO₂ sensor with exposed optical components. Do not immerse sensor completely in water, solvents, or cleaning solutions because the sensor and connectors are not waterproof. Do not sterilize SpO₂ sensors by irradiation, steam, or ethylene oxide. Refer to the cleaning instructions in the directions for use for reusable SpO₂ sensors.

WARNING: Inaccurate readings could result if a sensor is used incorrectly. Before using a sensor, carefully read and understand the sensor directions for use.

WARNING: Inaccurate measurements may be caused by:

- incorrect sensor application or use
- significant levels of dysfunctional hemoglobin (such as carboxyhemoglobin or methemoglobin)
- intravascular dyes such as indocyanine green or methylene blue
- exposure to excessive illumination, such as surgical lamps (especially ones with a xenon light source), bilirubin lamps, fluorescent lights, infrared heating lamps, or direct sunlight
- excessive patient movement
- high-frequency electrosurgical interference and defibrillators
- venous pulsations
- placement of a sensor on an extremity with a blood pressure cuff, arterial catheter, or intravascular line
- the patient has hypotension, severe vasoconstriction, severe anemia, or hypothermia
- there is arterial occlusion proximal to the sensor
- the patient is in cardiac arrest or is in shock

WARNING: Loss of pulse signal can occur in any of the following situations:

- the sensor is too tight
- there is excessive illumination from light sources such as a surgical lamp, a bilirubin lamp, or sunlight
- a blood pressure cuff is inflated on the same extremity as the one to which an SpO₂ sensor is attached

SETUP CONNECTION

Use only Nellcor sensor extension cables and SpO₂ sensors with the NPB-4000/C.

When selecting a sensor, consider the patient's weight and activity, adequacy of perfusion, availability of sensor sites, need for sterility, and anticipated duration of monitoring. For more information, refer to Table 22, page 76, or your local Nellcor representative.

Table 22: SpO₂ Sensors

Oxygen Transducer	Model	Patient Weight
<i>Oxysensor® II</i> (sterile, single use)	N-25* I-20 D-20 D-25 (L) R-15	<3 or >40 kg 3 to 20 kg 10 to 50 kg >30 kg >50 kg
<i>Oxicliq®</i> (sterile, single, use)	A P N* I	>30 kg 10 to 50 kg <3 or >40 kg 3 to 20 kg
<i>Dura-y®</i> (nonsterile, reusable)	D-YS* D-YSE	>1 kg >30 kg
<i>Durasensor®</i> (nonsterile, reusable)	DS-100A	>40 kg
Nellcor reflectance sensor (Nonsterile, limited reuse)	RS-10	>40 kg

*Although these Nellcor sensors are specified for use on very small patients, as well as pediatric and adult patients, the NPB-4000/C monitor should NOT be used to monitor neonates.

Observe all warnings and cautions in the directions for use supplied with these sensors. Carefully apply the sensor to the patient, as described in the sensor directions for use. The sensor may be connected directly to the NPB-4000/C front panel connector, identified with the SpO₂ icon. Typically, however, it is more convenient to connect the sensor to the monitor by using a Nellcor SpO₂ extension cable. Periodically check to see that the sensor remains properly positioned on the patient and that skin integrity is acceptable. Refer to sensor directions for use.

High ambient light sources such as surgical lights (especially those with a xenon light source), bilirubin lamps, fluorescent lights, infrared heating lamps, and direct sunlight can interfere with the performance of an SpO₂ sensor. To prevent interference from ambient light, ensure that the sensor is properly applied, and cover the sensor site with opaque material. Failure to take this action in high ambient light conditions may result in inaccurate measurements.

If patient movement presents a problem, verify that the sensor is properly and securely applied; move the sensor to a less active site; use an adhesive sensor that tolerates some patient motion; or use a new sensor with fresh adhesive backing.

For reusable sensors, follow the sensor directions for use for cleaning and reuse. For single-patient use sensors, use a new sensor for each patient. Do not sterilize any Nellcor sensor by irradiation, steam, or ethylene oxide.

CONTROLLING SpO₂ FUNCTIONS VIA NUMERIC FRAME

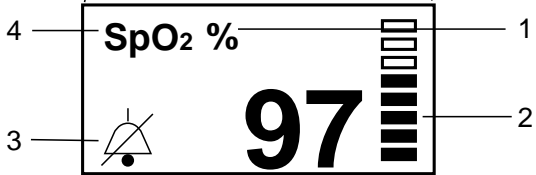
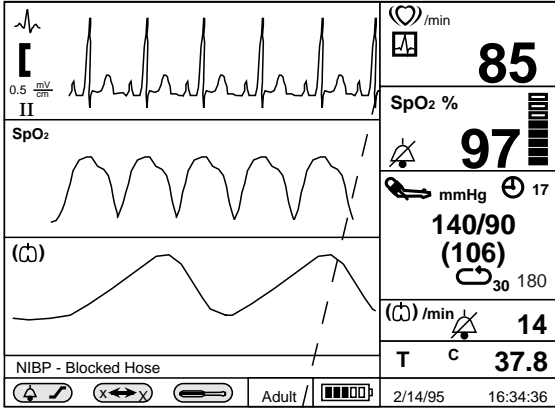

Figure 18: SpO₂ Screen

- 1. Units of Measure
- 2. Pulse Amplitude Indicator
- 3. Audible Alarm Bell Icon
- 4. SpO₂ Icon

Table 23: SpO₂ Menu

<i>Level 1 Menu</i>	<i>Level 2 Menus or Response</i>
<i>Title: SpO₂ MENU</i>	
SpO₂ Response	Slow, Normal, Fast
C-Lock	On, Off
SpO ₂ limits	Variable (refer to Table 13, page 50)
SpO ₂ alarm silence icon	On/Off (audible on)
Return	Exits Level 1 menu immediately, returns to Monitoring Screen

SpO₂ Response Modes

Normal (Mode 1): Recommended for most clinical situations in conjunction with *C-LOCK* ECG synchronization to reduce the effect of patient motion.

Fast (Mode 2): Useful for special applications such as sleep studies in which the user desires fast response. Most affected by patient motion.

Slow (Mode 3): Least affected by patient motion. Should be used only if Normal mode with *C-LOCK* does not perform acceptably. User must be aware that changes in SpO₂ are reported more slowly relative to other modes. Heart rate from SpO₂ is not displayed when slow response mode is enabled.

C-LOCK Operation

When *C-LOCK* is turned on in the SpO₂ menu, *C-LOCK* automatically becomes operational any time a valid ECG signal is detected by the monitor. It is not necessary to turn *C-LOCK* off if an ECG signal is not available; the monitor handles this function automatically.

If the ECG signal is noisy, or of poor quality, SpO₂ performance may be improved by turning *C-LOCK* off.

Pulse Amplitude Indicator

The pulse amplitude indicator is a segmented display within the SpO₂ numeric frame that shows the relative strength of the detected pulse. With each pulse, contiguous segments are briefly filled; the stronger the pulse, the greater the number of filled segments.

Pulse Search Condition

The NPB-4000/C displays a status message “SpO₂ Pulse Search” to indicate that it is attempting to locate the patient’s pulse. An SpO₂ sensor must be connected to the NPB-4000/C in order for the SpO₂ pulse search condition to occur.

CONTROLLING SpO₂ WAVEFORM VIA GRAPHIC FRAME

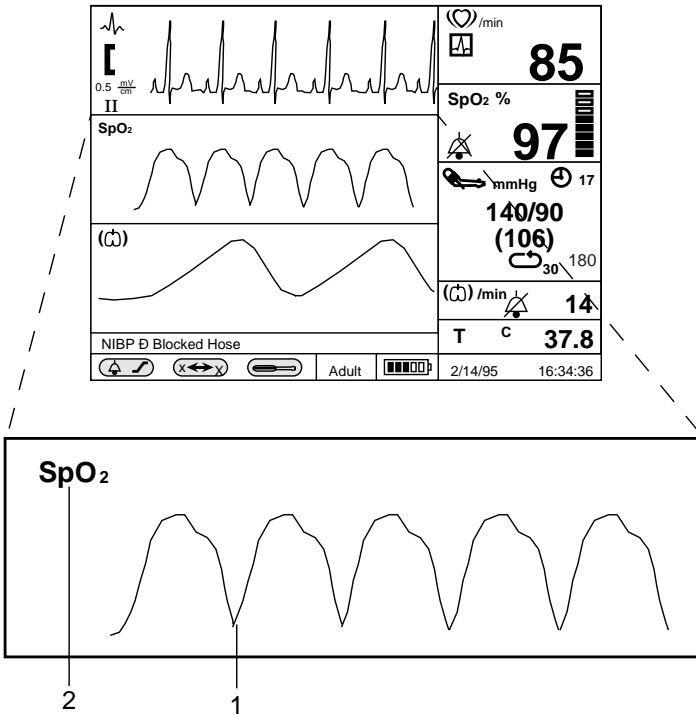

Figure 19: SpO₂ Waveform Screen

1. SpO₂ Waveform
2. SpO₂ Icon

Table 24: SpO₂ Waveform

<i>Level 1 Menu</i>	<i>Level 2 Menus or Response</i>
<i>Title: SpO₂ WAVEFORM</i>	
Sweep speed	12.5 mm/s, 25 mm/s, 50 mm/s
ECG Waveform >SpO₂ Waveform Respiration Waveform Tabular Trend HR Graphical Trend SpO₂ Graphical Trend NIBP Graphical Trend RR Graphical Trend Temperature Graphical Trend	No level 2 menu for these items; selection of a new graphic type immediately causes the title and the first menu items to update, reflecting the new choice.
Return	Exits Level 1 menu immediately, returns to Monitoring Screen

[THIS PAGE INTENTIONALLY LEFT BLANK]

RESPIRATION MONITORING

General

Respiration Safety Information

Setup Connections

Controlling Respiration Functions via Numeric Frame

Controlling Respiration Waveform via Graphic Frame

GENERAL

The patient's respiration is detected by using two of the three leads of the ECG electrodes and cable. A low-level excitation signal is applied to these leads, and the variation of the thoracic impedance caused by the breathing effort is sensed and processed for measurement and screen presentation.

Real-time respiratory information is presented as a waveform in a graphic frame; respiration rate is presented in a numeric frame and in tabular trend data.

RESPIRATION SAFETY INFORMATION

WARNINGS: The NPB-4000/C is a respiration rate monitor only. The NPB-4000/C should NOT be used for the detection of apnea. Do not use the NPB-4000/C to monitor neonates.

WARNING: Keep patients under close surveillance when monitoring respiration. Respiration signals are relatively more sensitive to interference from radiated electromagnetic signals. Thus, it is possible, although unlikely, that radiated electromagnetic signals from sources external to the patient and NPB-4000/C can cause inaccurate respiration readings. Do not rely entirely on the NPB-4000/C respiration readings for patient assessment.

SETUP CONNECTIONS

The respiration signal is acquired using the ECG electrodes, leads and cable. Refer to the **ECG Monitoring** section, page 55, for information regarding patient connection.

Respiration monitoring performance may be improved by an alternate electrode placement, relative to standard ECG electrode placement.

- Left arm (LA) electrode placement is the left midaxillary line just below the nipple level.
- Right arm (RA) electrode placement is the right midaxillary line just below the nipple level.
- Left leg (LL) electrode placement is unchanged relative to standard ECG lead placement.

The user should be aware that this alternate electrode placement may change the shape and amplitude of the ECG waveform.

CONTROLLING RESPIRATION FUNCTIONS VIA NUMERIC FRAME

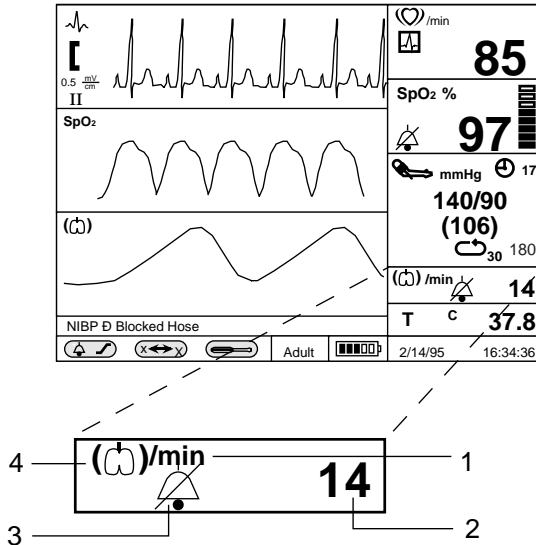

Figure 20: Respiration Rate Screen

1. Units of Measure
2. Measured Value
3. Audible Alarm Bell Icon
4. Respiration Icon

Table 25: Respiration Rate Menu

<i>Level 1 Menu</i>	<i>Level 2 Menus or Response</i>
<i>Title:</i> RESPIRATION RATE MENU	
Respiration	On, Off
Respiration rate limits	Variable (refer to Table 13, page 50)
Respiration rate alarm	On/Off (audible on)
Return	Exits Level 1 menu immediately, returns to Monitoring Screen

Loss of Respiration Signal Alarm

If the NPB-4000/C patient monitor does not detect a respiration signal for 40 consecutive seconds, a loss of respiration signal alarm will be issued. Check the condition of the patient, then check the condition of the electrodes and lead/cable connections. The alternate electrode placement described in **Setup Connections**, page 84, may improve respiration-monitoring performance. If poor signal quality persists, the user may choose to turn Off respiration monitoring, as described below.

CAUTION: When the respiration rate limits audible alarm has been permanently silenced (the slashed-bell icon is present), the loss of respiration signal audible alarm will also be permanently silenced.

Respiration Monitoring On/Off

When respiration monitoring is turned Off in the Respiration Rate menu, the respiration rate value and respiration waveform will be blanked, and no respiration monitoring alarms will function.

CONTROLLING RESPIRATION WAVEFORM VIA GRAPHIC FRAME

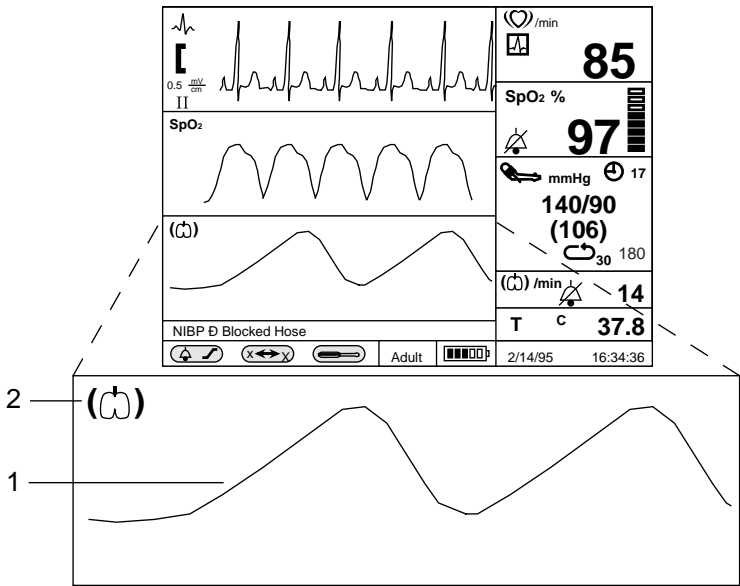

Figure 21: Respiration Waveform Screen

1. Respiration Waveform
2. Respiration Icon

Table 26: Respiration Waveform Menu

<i>Level 1 Menu</i>	<i>Level 2 Menus or Response</i>
<i>Title:</i> RESPIRATION WAVEFORM MENU	
Sweep Speed	6.25 mm/s, 12.5 mm/s, 25 mm/s
<i>other graphic choices:</i> ECG Waveform SpO2 Waveform >Respiration Waveform Tabular Trend HR Graphical Trend SpO2 Graphical Trend NIPB Graphical Trend RR Graphical Trend Temperature Graphical Trend	No level 2 menu for these items; selection of a new graphic type immediately causes the title and first menu items to update, reflecting the new choice.
Return	Exits Level 1 menu immediately, returns to Monitoring Screen

[THIS PAGE INTENTIONALLY LEFT BLANK]

TEMPERATURE MONITORING

General
Setup Connections
Controlling Temperature Functions via Numeric Frame

GENERAL

Measurement of patient temperature is accomplished by processing the signal from a probe containing a resistance element whose impedance is temperature dependent. These devices are called thermistors. The signal from the probe is conditioned by the monitor input circuitry, processed, and the measured values are shown in the numeric frame.

Setup Connections

The NPB-4000/C patient monitor is designed to accept signals from YSI Series 400-compatible thermistor probes. Interchangeable probes in this series may be used for esophageal, rectal, skin or surface, or airway temperature measurement. Follow the directions for use accompanying the temperature probe. If YSI-compatible probes are not readily available, contact Nellcor's Technical Services Department or your local Nellcor representative. To avoid nuisance limit alarms, the probe should be affixed to the patient before connecting to the NPB-4000 and NPB-4000C front panel connector.

CONTROLLING TEMPERATURE FUNCTIONS VIA NUMERIC FRAME

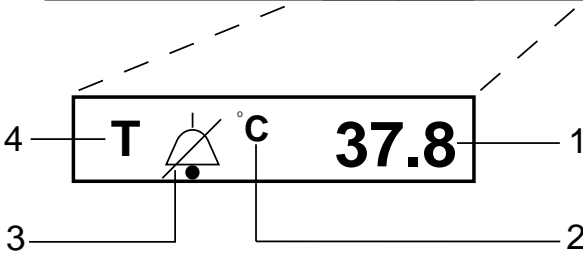
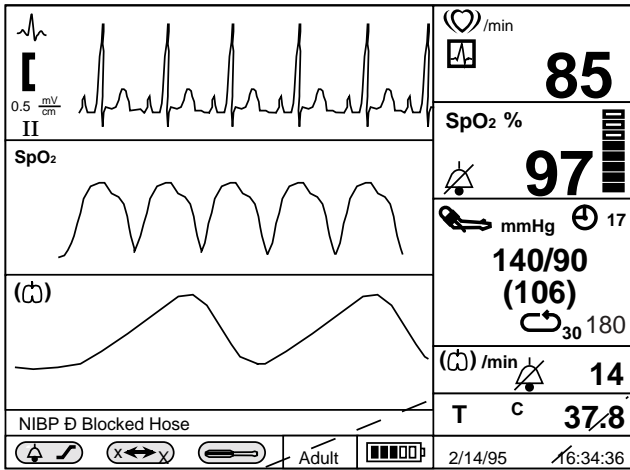

Figure 22: Temperature Screen

1. Measured Value
2. Units of Measure
3. Alarm Bell
4. Temperature Icon

Table 27: Temperature Menu

<i>Level 1 Menu</i>	<i>Level 2 Menus or Response</i>
<i>Title: TEMPERATURE MENU</i>	
Units	° C, ° F
Temperature limits	Variable (refer to Table 13, page 50)
Temperature alarm	On/Off
Return	Exits Level 1 menu immediately, returns to Monitoring Screen

TRENDS

- General
- Displaying Trend Data
- Selecting a 2-Hour Portion of the Graphical Trend for Display
- Printing Trend Information (Printer Option Installed)
- Changing the Vertical Scale Range
- Selecting Different Trend Records
- Graphical Trend Operation Summary
- Tabular Trend Data
- Transferring Trend via RS-232

GENERAL

Trend Data Storage

Trend Data in graphical or tabular format may be displayed on the screen, and printed if a printer is installed.

Trend data for all parameters except NIBP is the average of a 20-second sample of the data. For NIBP, the trend data is the measured values. Twelve (12) hours of trend data is stored in a nonvolatile memory, and remain in storage when the monitor is in Standby.

A new record of trend data is started each time the monitor is turned On. A trend data record is defined as the data from one power On event to the Standby power event. A date/time annotation is included at the start of each new record (up to ten are possible) so the record can be correlated with the patient.

Once trend memory has stored 12 hours of data, the oldest trend data will be overwritten by new data.

Trend Displays

Trend data is displayed in graphical or tabular format. Trend information in graphical format for a selected parameter is shown as a line connecting each of the points representing the stored 20-second average.

NIBP values are shown as vertical lines. The vertical displacement of the top of the line represents the systolic pressure, the bottom represents the diastolic pressure, and a short blank space in the line represents the mean arterial pressure values. Two hours of graphic trend data are displayed in one graphic frame.

There is one tabular trend format, containing trend data for all monitored parameters. The tabular trend data values are selected each time an NIBP measurement is made or once every 15 minutes, whichever comes first. In the event of an alarm condition, each 20-second average is shown until the alarm is corrected. In addition, during the alarm state, the limit(s) being exceeded are displayed in reverse video. The selected trend segment is obtained by user interaction with the menu.

DISPLAYING TREND DATA

1. Rotate the knob to highlight the graphic frame in which the desired trend is to appear.
2. Press the knob.
3. The Level 1 menu for this frame appears in graphics frames 2 and 3.
4. Rotate the knob to highlight the trend description item in the Level 1 menu.
5. Press the knob. Control is returned to the Level 1 menu.
6. Rotate the knob until the Return message is highlighted.
7. Press the knob.

The display now contains a graphical trend (if selected) or a tabular trend (if selected) in the previously highlighted graphic frame location.

Trend Screen Example

In Figure 23, page 93, tabular trend data for all monitored parameters is displayed in the middle graphics frame; graphical trend data for the SpO₂ parameter is displayed in the bottom graphics frame.

The newest data appears at the right of graphical trends, and at the top of tabular trends.

Additional control of trend operations is obtained by interaction with the trend display.

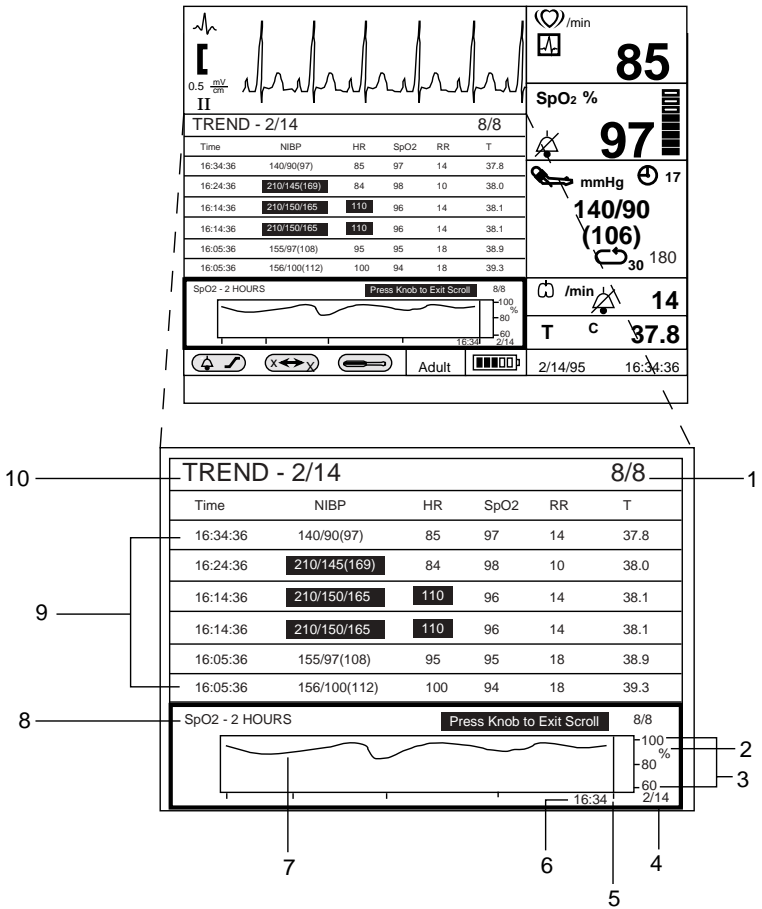

Figure 23: Graphical and Tabular Trend Screens

- | | |
|--------------------------------|----------------------------|
| 1. Record Number/Total Records | 6. Time |
| 2. Units of Measure | 7. Two Hours of Trend Data |
| 3. Vertical Axis Range Scale | 8. Title |
| 4. Date | 9. Five Tabular Rows |
| 5. Time Bar | 10. Title |

Figure 23 shows the eighth trend record out of eight stored, as indicated by the **8/8** in the upper right corner of the trend screen (**1/8** would be the current one). The time bar at the right edge of the trend graph indicates the most recent trend value in the display and corresponds to the time value displayed below it.

Two hours of graphical trend and five rows of tabular data are presented in their frames on the screen at any one time. The capability for viewing more trend data is obtained by using the scroll function.

SELECTING A 2-HOUR PORTION OF THE GRAPHICAL TREND FOR DISPLAY:

1. Rotate the knob until the trend graphics frame is highlighted. The highlighting is shown in Figure 23, page 93.
2. Press the knob.

The Level 1 menu for the waveform trend appears in graphic frames 2 and 3. (The menu may temporarily obscure the trend graphics frame.)

The first item is **Scroll/Print Trend**.

The display is shown in Figure 24, page 96.

3. Rotate the knob to highlight the top menu item **Scroll/Print Trend**.
4. Press the knob. The Level 1 menu is removed from the screen. The knob is now activated.
5. Rotate the knob to scroll through the record. Counterclockwise rotation moves the 2-hour window forward in time; clockwise rotation backs up the window. Each rotational “click” of the knob moves the window in 15-minute increments.
6. After viewing the trend, press the knob again to exit the scrolling function and return to the Level 1 menu. If no other changes are desired, select Return to **Return** to the normal monitoring screen.

PRINTING TREND INFORMATION (PRINTER OPTION INSTALLED):

Follow the instructions (above) to enable the knob for scrolling operation.

At the side-panel printer controls, press the *Continuous* switch to print the entire trend record.

Press the *Snapshot* switch to print only the portion of the record shown on the screen.

CHANGING THE VERTICAL SCALE RANGE

The user via interaction with a Level 2 menu may select the range of the vertical axis of a graphical trend. The presentation can be tailored to show the best resolution, depending upon the variation of the data in the screen. An example is shown in Figure 24, page 96.

1. Call the Level 1 menu to the screen, as previously described.
2. Rotate the knob to highlight **Range** in the menu.
3. Press the knob. The choices of range values for the measured parameter appears as a pop-up Level 2 menu.
4. Rotate the knob to highlight the desired range.
5. Press the knob. The graphical trend is now scaled for the selected range, which is also shown along the right-hand vertical axis.

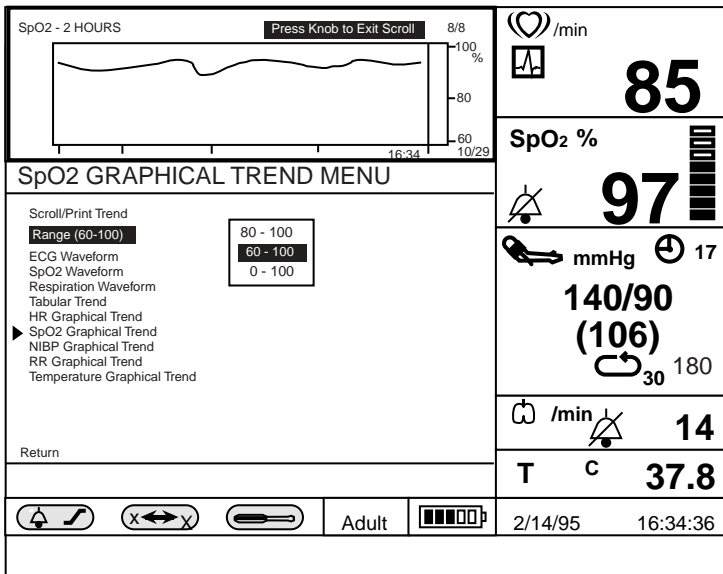

Figure 24: Accessing the Trend Scroll Capability

SELECTING DIFFERENT TREND RECORDS

Only data from one record may appear in the graph at a time. When a user is scrolling through a previously stored Graphical Trend and reaches the end of the record, a blank space appears as the trend data progresses off the graph.

As the knob is turned, the time and date display in the frame is updated to reflect the time/date of the time bar. If the user is scrolling “forward” in time, as the end of the record is reached, the vertical time bar and the time display will follow the last (newest) data point in that record off the left end of the graph. The next newest trend record in memory will then appear in the graph.

If the user is scrolling “back” in time, the process is reversed. The record number digit updates appropriately as the trend records are accessed. If the user attempts to scroll beyond the end of the trend data the monitor will generate a warning tone.

GRAPHICAL TREND OPERATION SUMMARY

Graphical trends may be presented for each of the monitored vital signs (Heart Rate, Oxygen Saturation, Blood Pressures, Respiration Rate, and Temperature). The procedures for presenting the graphical screens, scrolling to select a desired 2-hour segment, changing the vertical range scale, and printing, are the same for each. The choices for the vertical range scale, however, are different.

A summary of the user interactions with the screen is shown in Table 28 for the SpO₂ graphical trend frame. The same font conventions are used as in previous tabular summaries.

Table 28: SpO₂ Graphical Trend Menu

<i>Level 1 Menu</i>	<i>Level 2 Menus or Response</i>
<i>Title: SpO₂ GRAPHICAL TREND MENU</i>	
Scroll/Print Trend	No Level 2 menu. The knob is activated for scrolling.
Range	0-100, 60-100, 80-100
<i>other graphic type choices:</i> ECG Waveform SpO₂ Waveform Respiration Waveform Tabular Trend HR Graphical Trend >SpO₂ Graphical Trend NIPB Graphical Trend RR Graphical Trend Temperature Graphical Trend	No Level 2 menu for these items; selection of a new graphic type immediately causes the title and the first menu items to update, reflecting the new choice.
Return	Exits Level 1 menu immediately, returns to Monitoring Screen

TABULAR TREND DATA

The procedures for selecting and manipulating tabular trend data are similar to those for graphical trend data.

- There is only one tabular trend screen display.
- Data from only one record may appear in the frame at a time.
- Once scrolling is enabled, each rotational “click” of the knob moves the table by one row.
- When a user is scrolling through a previously stored Tabular Trend and reaches the end of the record, a blank space appears as the trend data progresses off the frame.
- If the user is scrolling “back” in time, the last entry will exit off the top of the frame. If the user continues to turn the knob after the last entry has scrolled off the frame, the next oldest trend record in memory will appear in the frame, entering from the bottom side.
- If the user is scrolling “forward” in time, the last entry will exit off the bottom of the frame. If the user continues to turn the knob after the last entry has scrolled off the frame, the next newest trend record in memory will appear in the frame, entering from the topside.
- The “record number” digit updates appropriately as the trend records are accessed.

TRANSFERRING TRENDS VIA RS-232

The entire trend memory can be transferred to an external computer via the RS-232 interface. Refer to the **RS-232 INTERFACE** section, page 117, for details.

PRINTING

General

GENERAL

When the optional printer is installed, two types of real-time printed records may be obtained by pressing the appropriate switch on the printer in the right panel.

SNAPSHOT

A 20-second print, recording real-time graphical and numeric information beginning with the values 10 seconds before the print initiation and ending 10 seconds after that event.

In addition, when the **Print-on-alarm** operation is selected in the Alarm/Limits menu, a SNAPSHOT printout is made automatically when a high or medium priority out-of-limits alarm condition is detected.

CONTINUOUS

A print of real-time graphical and numeric information, beginning 10 seconds before initiating the action and continuing until stopped.

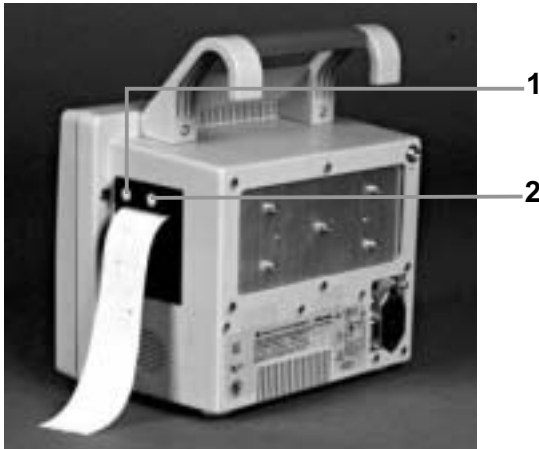

Figure 25: Printer Operator Controls

1. Snapshot Switch
2. Continuous Switch

Pressing either of the two printer buttons can stop printing in any mode.

The following information is printed in both continuous and snapshot mode.

- **Current numeric values:** Heart rate (HR), oxygen saturation (SpO₂), blood pressures (Sys/Dia/MAP), respiration rate (RR), and temperature (T) are printed along the top of the paper. Time is printed along the bottom of the paper.
- **Real-time waveforms** of the two top graphics frames on the display.

The user configures the print record by selecting the graphics for the top two frames and the parameter values of those graphics.

The ECG waveform printout includes: sweep speed, amplitude scaling (size), and lead configuration (I, II, or III) used for the measurements. If extended low frequency range is active, “ELF” will appear on the printout.

NOTE: If the sweep speed in frames 1 and 2 are 6.25, 12.5, or 25 mm/s, the print speed will be 25 mm/s. If the sweep speed on the display is 50 mm/s, the print speed will be 50 mm/s. If frames 1 and 2 have waveforms of different speeds, the printout will occur at the faster speed.

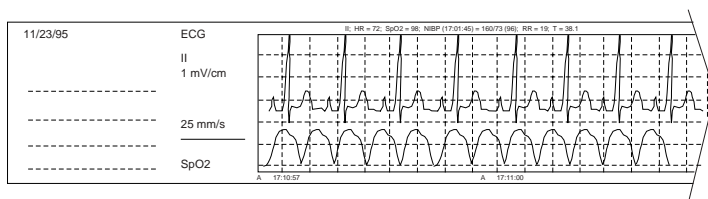

Figure 26: Real-Time Printout

Print-on-Alarm:

In the Alarm/Limits menu, a “Print-On-Alarm” option is provided. A snapshot print is initiated upon detection of an alarm event. Out-of-limits readings are enclosed in brackets. Instructions for setting this mode are detailed in the **Alarms and Limits** section, page 41.

Trend Print

When the knob scrolling function is enabled for a trend frame, pressing the *Snapshot* switch on the printer prints the displayed graphical or tabular trend data. The Snapshot printout contains only the data shown on the screen at that time.

When the *Continuous* switch on the printer is pressed, the full record, as stored to date, is printed.

Only one trend record may be printed at a time.

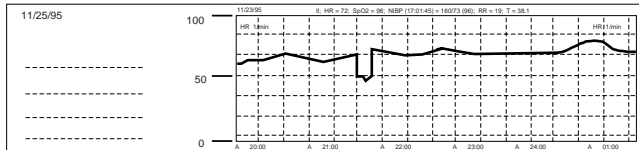

Figure 27: Graphic Trend Printout

See Figure 27. Characteristics of the graphical trend printout are as follows.

- The graphical trend printout begins with the standard header, followed by the graphical trend itself.
- The title of the trend appears near the top, at the beginning of the trend.
- The date of the oldest trend data being printed appears in the upper annotation area at the beginning of the trend.
- The oldest data appears on the left.

11/25/95	11/23/95	00/17/28	00/12/28	00/07/28	00/07/25	00/06/43	00/02/23	23/07/28
HR 14min	72	72	72	72	72	72	72	72
SpO2 %	93	93	93	93	93	93	93	93
Sys	157	157	157	---	---	---	157	157
DiA	81	81	81	---	---	---	81	81
MAP	102	102	102	---	---	---	102	102
RR 14min	16	16	16	16	16	16	16	16
T	38.5	38.5	38.5	38.5	38.5	38.5	38.5	38.5

Figure 28: Tabular Trend Printout

See Figure 28, page 101. Characteristics of the tabular trend printout are as follows.

- The tabular trend printout begins with the standard header followed by a column of information.

- The date of the newest trend data is at the top of the list, followed by labels and units for each of the monitored parameters.
- Next is a series of columns of tabular trend data, each headed by the time the data in that column was captured.
- Newer data appears to the left of older data.
- Out-of-limits values are enclosed in brackets.

OPERATOR MAINTENANCE AND TROUBLESHOOTING

Error Messages
Service
Obtaining Technical Assistance
Returning System Components
Printer Paper Replacement

ERROR MESSAGES

An Error message is displayed when a malfunction is detected that prevents further use of the monitor until the malfunction is corrected.

If the NPB-4000/C is unable to perform any of its monitoring functions because of the loss of software control or because of a detected hardware malfunction, an Error screen appears in which an error code is presented, along with instruction to refer to this manual.

Serviceable error codes and other error codes are listed in the NPB-4000/C service manual. Contact your service personnel or record the error code number. Before calling the local Nellcor representative, make sure that the battery is charged, and that all power connections are correctly made. If the monitor continues to present the Error screen, call the Nellcor technical representative and report the error code number. You will be advised of the remedial action to be taken.

SERVICE

WARNING: If you are uncertain about the accuracy of any measurement, check the patients vital signs by alternate means, then make sure the monitor is functioning correctly.

The NPB-4000/C requires no routine service other than cleaning, battery maintenance, and that which is mandated by the user's institution. Complete service instructions are contained in the NPB-4000/C service manual.

Qualified service personnel in the user's institution should perform periodic inspections of the monitor.

If the institution's service personnel cannot correct problems, the NPB-4000/C should be returned to Nellcor for service. Contact Nellcor's Technical Services Department or your local representative for return instructions.

Cleaning

WARNING: The cover should be removed only by qualified service personnel. There are no internal user-serviceable parts.

WARNING: Do not spray, pour, or spill any liquid on the NPB-4000/C patient monitor, its accessories, connectors, switches, or openings in the chassis.

To clean the monitor, dampen a cloth with a commercial, nonabrasive cleaner and wipe the top, bottom, and front surfaces lightly. For cables, sensors, and cuffs, follow cleaning instructions in the directions for use shipped with those components.

If liquid is accidentally spilled on the monitor, clean and dry thoroughly before reuse.

If in doubt about monitor safety, refer the unit to qualified service personnel.

Battery Maintenance

If the NPB-4000/C patient monitor has not been used one month, the battery will need charging. To charge the battery, connect the NPB-4000/C to an AC outlet or external DC supply as described in the **Setup and Use** section, page 21.

Note: Storing the NPB-4000/C for a long period without charging the battery may degrade the battery capacity. A complete battery recharge requires 8 hours.

CAUTION: If the NPB-4000/C is to be stored for a period of 2 months or longer, notify service personnel to remove the battery from the monitor prior to storage. Recharge the battery when the battery has not been recharged for 2 or more months.

CAUTION: Follow local government ordinances and recycle instructions regarding disposal or recycling of device components, including batteries.

Nellcor recommends that the NPB-4000/C's sealed, lead-acid battery be replaced at 2-year intervals. Refer to the NPB-4000/C service manual for battery replacement and general service instructions. Follow local governing ordinances and recycling plans regarding disposal or recycling of batteries and other device components.

OBTAINING TECHNICAL ASSISTANCE

For technical information and assistance, or to order an NPB-4000/C service manual, call Nellcor's Technical Services Department or your local Nellcor representative. The service manual includes information required by qualified service personnel when servicing the NPB-4000/C.

RETURNING SYSTEM COMPONENTS

Contact Nellcor's Technical Services Department or your local Nellcor representative for shipping instructions including a Returned Goods Authorization number. It is not necessary to return the sensors or cables. Pack the NPB-4000/C patient monitor in its original shipping carton. If the original carton is not available, use a suitable carton with appropriate packing material to protect the monitor during shipping.

Return the NPB-4000/C by any shipping method that provides proof of delivery.

PRINTER PAPER REPLACEMENT

Caution: Use only Nellcor supplied paper.



Figure 29: Loading Thermal Paper in Printer

1. Paper Eject Switch

Load thermal paper as described in the following procedure:

1. Open the door at the front of the printer by pressing the *Paper Eject* Switch identified in Figure 29. The door should tilt open.
Note: If the printer's door does not open completely, pull it towards you until it is completely open.
2. Reach in and remove the spent paper core by pulling it towards you gently.
3. Place a new paper roll between the two round tabs of the paper holder. Orient the paper roll as shown in Figure 29.

Note: The paper roll is easier to load if it is held horizontally with your thumb underneath it and your forefinger and/or index finger on top. Your thumb will hold the loose paper in place.

4. Pull the paper towards you until approximately 4 inches (10.16 cm) of paper have been unrolled.
5. Align the paper with the pinch roller attached to the printer door.
6. Holding the paper against the roller, close the printer door.
7. To ensure that the paper is aligned in the slot and has not been pinched in the door, pull the loose edge until a few inches of paper is showing. If the paper will not move, open the door and return to alignment step 5.
8. The printer should now be ready for operation.

[THIS PAGE INTENTIONALLY LEFT BLANK]

SPECIFICATIONS

- Scope
- General
- Electrical
- Environmental
- Measuring Parameters
- Trends

SCOPE

This section includes specifications for the NPB-4000/C. The instrument is designed to monitor patient vital signs, including: electrocardiogram and heart rate, respiration rate, non-invasive blood pressure, blood oxygen saturation, and temperature. In addition to displaying the instantaneous values of the measured parameters, the NPB-4000/C includes provisions for displaying waveform data, as well as trends in graphical and tabular format. The optional printer provides hard copy printing.

GENERAL

Size:	10.6 in. x 8.6 in. x 6.5 in. (26.9 cm x 21.8 cm x 16.5 cm) excluding handle
Weight:	10.8 lb (4.9 kg) excluding accessories, options, cables
Display:	
NPB-4000	
Screen Type:	Liquid Crystal Display (LCD) Monochrome, Cold Cathode Fluorescent Backlit
Screen Size:	151 mm x 113 mm (NPB-4000)
NPB-4000C	
Screen Type:	Liquid Crystal Display (LCD) Color, Cold Cathode Fluorescent Backlit
Screen Size:	130 mm x 97 mm (NPB-4000C)
Resolution:	640 x 480 pixel

Printer (Optional):

Type:	Thermal
Weight:	0.9 lb (0.4 kg)
Paper Width:	50 mm
Speeds:	25 mm/s and 50 mm/s

Safety Standards: IEC 601-1, UL 2601, Can/CSA C22.2 601.1

Protection Class: Class I, internally powered equipment: per I.E.C. 601-1, clause 2.2.4

Degree of Protection: Type CF: per I.E.C. 601-1, clause 2.2.26

Mode of Operation: Continuous

ELECTRICAL

Power Sources:

Internal Battery: 6 V, 8 Ampere-Hours;
Type, sealed lead-acid

Operating Time:

NPB-4000 4 hours typical @ 25° C, no printing,
one NIBP measurement per 15 min.
(fully charged battery)

NPB-4000C 3 hours typical @ 25° C, no printing,
one NIBP measurement per 15 min.
(fully charged battery)

AC Mains: 100 VAC to 240 VAC, 50 Hz to 60
Hz,
1 A max

DC (External): 10 VDC to 16 VDC, 5A max

ENVIRONMENTAL

Mechanical Shock:	IEC 68-2-27, 100g; 6 msec; three axes, 18 total shocks, non-operating
Mechanical Vibration:	
Sinusoidal:	IEC 68-2-6, 10 Hz to 58 Hz; 0.15 in. displacement 58 Hz to 150 Hz; 2 g acceleration 4 min/sweep; 20 sweeps/axis, non-operating
Thermal:	
Operating Temperature:	0° C to 50° C
Storage Temperature:	-20° C to 60° C
Humidity:	
Operating:	5 % RH to 95% RH, non-condensing
Storage:	5 % RH to 95% RH, non-condensing
Water Resistance:	IEC 529 Classification IPX1 (Protected against vertically dripping water)
Altitude:	0 ft – 10,000 ft (operating)
Electromagnetic Compatibility:	Radiated and conducted electromagnetic energy per CISPR 11, Class B

MEASURING PARAMETERS**ECG Measurement/Display**

Heart Rate Range:	20 BPM to 250 BPM
Heart Rate Accuracy:	±5 BPM
Bandwidth Normal Monitoring:	0.5 Hz to 40 Hz

Specifications

Bandwidth, Extended Low Frequency Response:	0.05 Hz to 40 Hz (User selectable)
Leads:	3 Lead, user selectable
Display Sweep Speeds:	12.5 mm/sec, 25 mm/sec, and 50 mm/sec
Pacemaker Detection:	Indicator on waveform display, user selectable
ECG Size (sensitivity):	0.5 mV/cm, 1 mV/cm, 2, 4 mV/cm
Lead Off Detection:	Detected and displayed
Input Impedance:	>5 M Ω
CMRR (common mode rejection ratio):	>90 dB at 50 Hz or 60 Hz
Input Dynamic Range:	± 5 mV AC, ± 300 mV DC
Defibrillator Discharge:	<5 sec per IEC601-2-27
Recovery:	<8 sec per AAMI EC13-1992

Standards: Meets the performance standards of ANSI/AAMI EC13-1992. Instead of a 1 mV standardization voltage (<i>section 3.2.2.9</i>), a fixed, 1 cm reference bar is always present in the ECG display, along with the ECG size setting expressed in mV/cm. The following references particular sections of ANSI/AAMI EC13-1992.	
Respiration, leads-off sensing waveform. <i>3.1.2.1(b)</i>	Applied current less than 0.25 microamperes.
Tall T-wave rejection. <i>3.1.2.1(c)</i>	T-wave of 0.8 mV amplitude will not affect heart rate determination.
Heart rate averaging. <i>3.1.2.1(d)</i>	Averages six of the most recent eight detected R-R intervals excluding the longest and shortest of the eight intervals.
Response to irregular rhythm. <i>3.1.2.1(e)</i>	a) Ventricular bigeminy - 80 BPM b) Slow alternating ventricular bigeminy - 60 BPM. c) Rapid alternating ventricular bigeminy - 120 BPM d) Bi-directional systoles - 89 to 96 BPM
Heart rate meter response time. <i>3.1.2.1(f)</i>	a) Change from 80 to 120 BMP: 4 to 6 sec b) Change from 80 to 40 BPM: 6 to 7 sec

Heart rate meter response time. 3.1.2.1(g)	<u>Waveform 4(a), Amplitude</u>	<u>Average Time to Alarm</u>
	0.5 mV	4 sec
	1 mV	4 sec
	2 mV	4 sec
	<u>Waveform 4(b), Amplitude</u>	<u>Average Time to Alarm</u>
	1 mV	3 sec
	2 mV	3 sec
	4 mV	3 sec
Pacemaker pulse rejection. 3.1.4.1, 3.1.4.2	With the exceptions noted below, the monitor will reject all pacemaker pulses having amplitudes of ± 2 to ± 700 mV and pulse widths from 0.1 to 2.0 ms, with and without under/overshoot. Following are pacer pulse conditions which the monitor will reject, but which are less than the maximum range listed in the standard:	
	Pacer pulse width = 2 ms, double pulse, without over/undershoot, no QRS	Pacer amplitude = ± 300 mV
	Pacer pulse width = 2 ms, single and double pulse, with 2 mV over/undershoot, no QRS	Pacer amplitude = ± 300 mV
	Pacer pulse width = 0.1 ms, double pulse, with 2 mV over/undershoot, ineffective pacing	Pacer amplitude = 300 mV, -400 mV

Respiration Measurement/Display

Technique:	Trans-thoracic impedance
Range:	3 breaths/min to 150 breaths/min
Accuracy:	± 3 breaths/min
Leads:	RA to LA
Display Sweep Speeds:	6.25 mm/s, 12.5 mm/s, 25 mm/s
Lead Off Condition:	Detected and displayed

Specifications

NIBP (Non-Invasive Blood Pressure) Measurement/Display

Technique:	Oscillometric
Measurement Modes:	
AUTO:	Automatic BP measurements at intervals of 1, 3, 5, 10, 15,30, 60, and 90 minutes
MANUAL:	Single measurement initiated by <i>NIBP Start/Stop</i> switch
STAT:	Series of consecutive measurements for 5 minutes
Cuff Pressure Display:	10 mmHg to 300 mmHg
Blood Pressure Measurement Range: ¹	
Systolic:	60 mmHg to 250 mmHg
Mean Arterial Pressure:	45 mmHg to 235 mmHg
Diastolic:	40 mmHg to 220 mmHg
Pulse Rate Range:	40 BPM to 200 BPM
Blood Pressure Accuracy:	Mean error and standard deviation per ANSI/AAMI SP10-1992.
Pulse Rate Accuracy:	Greater of ± 2 BPM or $\pm 2\%$
Initial Cuff Inflation:	180 mmHg (factory default)
Subsequent Cuff Inflation:	Prev SYS +50 mmHg Auto Mode Prev SYS +40 mmHg STAT Mode
Standards:	Meets performance standards of ANSI/AAMI SP10-1992

¹ Systolic and diastolic blood pressure measurements determined with this device are equivalent to those obtained by a trained observer using the cuff/stethoscope auscultation method, within the limits prescribed by the American National Standard, *Electronic or automated sphygmomanometers*.

Temperature Measurement/Display

Technique:	Thermistor probe (YSI 400 series compatible)
Range:	15° C to 45° C
Accuracy:	±0.1° C

SpO₂ Measurement/Display

Range:	
% Saturation:	0% to 100%
Pulse Rate:	20 BPM to 250 BPM
Accuracy: ²	
SpO ₂ :	70% to 100%: ±2 digits 0% to 69%: Unspecified
Pulse Rate:	±3 BPM

TRENDS

Types:	Graphical and Tabular
Memory Storage:	12 hours, nonvolatile
Data Interval:	20 seconds: (Stored data point is the average over 20-second interval)
Graphical Format:	One graph per vital sign
Display Range:	2 hours, scrollable
Vertical Scaling:	
Heart rate:	50 to 100, 0 to 250, 25 to 125 BPM
NIBP:	50 to 100, 0 to 150, 0 to 300 mmHg
SpO ₂ :	0% to 100, 60% to 100, 80% to 100%

² SpO₂ accuracies are expressed as plus or minus "X" digits (saturation percentage points) between saturations of 70 to 100%. This variation equals plus or minus one standard deviation (1SD), which encompasses 68% of the population. All accuracy specifications are based on testing the subject monitor on healthy adult volunteers in induced hypoxia studies across the specified range. Adult accuracy is determined with *Oxisensor*[®] // D-25 sensors.

Specifications

Respiration Rate:	0 BPM to 20 BPM, 0 BPM to 50 BPM, 0 BPM to 150 BPM
Temperature ° C:	15° C to 45° C, 33° C to 41° C, 35° C to 39° C
Temperature ° F:	55° F to 115° F, 91° F to 107° F, 96° F to 102° F
Tabular Format:	One table for all variables. Six fields per row (time and 5 vital signs)
Display Interval:	Per NIBP measurement, or 15 minutes for no NIBP, or 20 seconds during alarm condition.

RS-232 INTERFACE

- Overview
- Cable Connections
- Nurse Call
- Exporting Trend Data

OVERVIEW

Patient data can be obtained through the RS-232 I/O connector on the rear panel of the monitor by connecting it to an attached PC. See Figure 2, page 13.

CAUTION: Do not download patient data when the monitor is monitoring a patient. Downloading patient data while monitoring a patient causes the monitor to lock up.

CABLE CONNECTION

The 9-pin connector mounted on the rear panel (see Figure 2 item 5, page 13) provides an access port for a serial (RS-232) interface to a suitably configured personal computer. Alternatively, qualified service personnel can use the connector to send a Nurse Call signal.

Table 29: RS-232 Serial Interface Connections

Pin #	Signal	Direction
1	not used	
2	Rx data	<<<<
3	Tx data	>>>>
4	DTR	>>>>
5	Signal ground	
6	DSR	<<<<
7	RTS	>>>>
8	CTS	<<<<
9	Alarm out	>>>>

NURSE-CALL

One of the pins in the rear panel connector for the RS-232 serial port can be used to send a Nurse Call signal when an alarm condition is detected. Connection must be accomplished by qualified service personnel. Refer to the NPB-4000/C service manual for instructions.

EXPORTING TREND DATA

In order to download trend data from the NPB-4000/C, communication software, such as ProComm™, should be installed in the external computer. The transfer protocol should be set as follows:

Baud Rate:	19,200
Data Bits:	8
Start Bit:	1
Stop Bits:	1
Parity:	None

Connect the NPB-4000/C to the serial port of the computer using a null modem cable. Start the communication program on the computer and enter terminal emulation mode. To initiate the transfer, type **tr** (lower case is necessary), followed by a carriage return <cr>.

If the command is not accepted, the response to an invalid command is “??”, followed by a carriage return <cr>.

In response to a valid command, the NPB-4000/C will send a comma-delimited ASCII text file comprising the entire contents of the NPB-4000/C’s trend memory. Each line is divided into five main groups, separated by a space <sp> and ending with a carriage return <cr> and line feed <lf>. The format for each line is:

```
RECORD<sp>DATE<sp>TIME<sp>ALARMS<sp>VITALS<cr><lf>
```

The fields within each group are identified and defined as follows:

RECORD:

record number,

Format:

2 characters
no leading zero suppression
right justified

DATE:

day, month, year,

Format:

day: 2 characters
month: 2 characters
year: 4 characters
no leading zero suppression
right justified

TIME:

hours, minutes, seconds,

Format:

2 characters
no leading zero suppression
right justified

ALARMS:

heart rate alarm, SpO2 alarm, respiration rate alarm, systolic pressure alarm, diastolic pressure alarm, mean arterial pressure alarm, temperature alarm,

Each field in this group is either:

0: corresponding vital sign was not in alarm state

or,

1: corresponding vital sign was in alarm state

VITALS:

heart rate, SpO₂, respiration rate, systolic pressure, diastolic pressure, mean arterial pressure, temperature,

Field Name	Units	Format
Heart rate	1/min	4 characters; leading zeroes suppressed; right justified
SpO ₂	%	4 characters; leading zeroes suppressed; right justified
Respiration rate	1/min	4 characters; leading zeroes suppressed; right justified
Systolic pressure	mmHg	4 characters; leading zeroes suppressed; right justified
Diastolic pressure	mmHg	4 characters; leading zeroes suppressed; right justified
Mean arterial pressure	mmHg	4 characters; leading zeroes suppressed; right justified
Temperature	degree C (no degrees F)	4 characters, including decimal point; leading zero not suppressed; right justified

If no vital sign was measured during a 20-second trend interval, characters in the corresponding field will be blank (<sp><sp><sp><sp>.). If the vital sign displayed dashes during a 20-second trend interval, characters in the corresponding field will contain dashes (----.).

Example of several lines of a trend file:

```
01, 04,02,1995,08,37,22,0,0,0,0,0,0, 72, 96, 19, 140, 90, 106,37.8,
01, 04,02,1995,08,37,02,0,1,0,0,0,0,0, 69, 82, 20, , , , ,38.0,
02, 04,01,1995,22,43,05,0,0,0,0,0,0, 103,----, 10, , , , , ,38.2,
02, 04,01,1995,22,42,45 0,0,0,0,0,0, 103,----, 9, 127, 73, 95,38.1,
```

DEFIB SYNC OUTPUT

DEFIB SYNC OUTPUT

The NPB-4000/C's Defib Sync output feature provides an ECG synchronization signal that can be used by some defibrillators for the purpose of performing synchronized cardioversion.

WARNING: Nellcor provides the electrical performance specifications for the NPB-4000/C Defib Sync signal, and provides an optional Defib Sync Cable, with the correct connector. It is the responsibility of the user to add the appropriate defibrillator connector and to ensure that the NPB-4000/C and the user's defibrillator perform safely and effectively when connected. Improper operation may result in harm to the patient.

NPB-4000/C DEFIB SYNC

Signal Specifications

Signal level:	0 - 5 V pulse
Pulse width:	100 ±10 ms
Delay from R-wave peak to start of pulse:	35 ms, maximum, per AAMI EC13
Short circuit current:	15 mA
Minimum required R-wave amplitude:	0.5 mV

Directions for use of the NPB-4000/C's Defib Sync feature are included with the Defib Sync Cable.

WARNING: Prior to use for cardioversion, the user must thoroughly test the NPB-4000/C connected to the defibrillator to ensure that the units function safely and effectively as a system.

OPTIONAL ACCESSORIES

- Printer
- GCX Mount
- Accessory Bag
- Defib Sync Cable
- DC Input Cable

PRINTER

Replacement paper (carton of 10 rolls) may be ordered. Contact your Nellcor sales representative for pricing and ordering information.

GCX MOUNT

A GCX mounting plate may be installed on the rear panel of the NPB-4000/C, making the NPB-4000/C compatible with the GCX mounting system. Components of the GCX system include a roll stand and a wall mount. Contact your Nellcor sales representative for further information about GCX mounting components.

ACCESSORY BAG

A zippered accessory bag, which attaches with snaps to the left side of the NPB-4000/C, is available for storing items such as an NIBP cuff and sensors. Contact your Nellcor sales representative for pricing and ordering information.

DEFIB SYNC CABLE

Qualified service personnel must configure the Defib Sync Cable. Refer to the **DEFIB SYNC OUTPUT** section, page 122, for more information. Contact your Nellcor sales representative for pricing and ordering information.

DC INPUT CABLE

Qualified personnel must configure the DC input cable. Contact your Nellcor sales representative for pricing and ordering information.

tyco

Healthcare

Nellcor

Nellcor Puritan Bennett Inc.
4280 Hacienda Drive
Pleasanton, CA 94588 USA
Telephone Toll Free 1.800.NELLCOR

Tyco Healthcare UK LTD
Fareham Road
Gosport
PO13 0AS
U.K.
Tel: 44.1329.224202

Rx ONLY

